

---

**Future Living**

Safe, vibrant cities for young and old

---

**Modern Mobility**

Reliable, self-driving electric mobility

---

**Security and Crisis Management**

Keeping us all safe when things go wrong

---

EDITION 01

**Research  
Spotlights**





## President's Foreword

Scientific research is central to a university's mission. Excellent research is the foundation for excellent teaching and sets the stage for a university to attract and train young scientists. This magazine will give you a first impression of a selection of research projects currently being conducted at the Universität der Bundeswehr München. It features projects from the University as well as from the "University of Applied Sciences". The Universität der Bundeswehr München is divided almost equally between technical faculties and faculties in the social sciences, and both of these are represented here.

One of the smaller universities in the Munich area, we have decided to promote our interdisciplinary research projects in order to enhance our profile. We hope to significantly increase both scientific expertise at the University and the visibility of the work we are conducting among the wider public. In addition to the research centers established in recent years, the University continues to thrive on the wide range of projects and scientists who conduct excellent research either individually or in cooperation with other universities.

This magazine can only give you a brief glimpse into our scope of research – we hope you learn something interesting and enjoy the read!

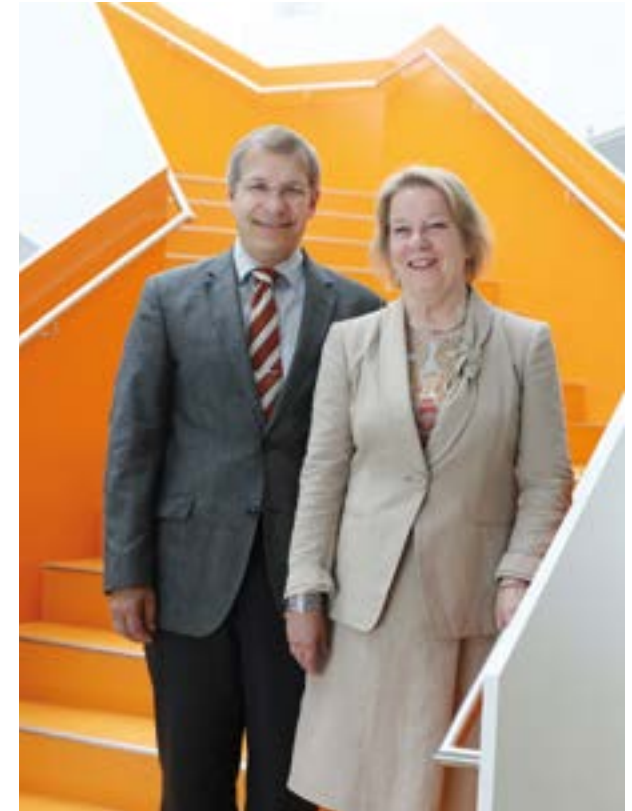

*Prof. Dr. Merith Niehuss, President (right) and  
Prof. Dr.-Ing. Karl-Christian Thienel, Vice-President  
Research (left)*

## Future Living



The homes and cities of tomorrow will not look the same as they do today. They will be designed to represent the needs of an aging population, and protect against possible natural disasters or terrorist attacks.

### **The Future of Living in an Aging Society**

Helga Pelizäus-Hoffmeister and Kristin Paetzold ..... 08

### **Keeping our Cities Safe**

Norbert Gebbeken ..... 14

### **Regenerating Inner-city Districts at the Expense of the Urban Mix**

Axel Schaffer ..... 20

# Modern Mobility



Imagine the future of mobility, and what do you see? Self-driving cars with environmentally friendly electric motors. Seamless interaction between advanced technological components. Shared vehicles. Safer vehicles.

<b>Powering the Future of Electric Mobility</b>	
Dieter Gerling .....	30
<b>Sharing: The Future of Urban Mobility</b>	
Klaus Bogenberger .....	36
<b>Testing for Excellence</b>	
Thomas Kuttner .....	42
<b>Autonomous Driving in Unstructured Environments</b>	
Hans-Joachim Wünsche .....	48

# Security and Crisis Management



Planning involves preparing for when things go wrong. How should authorities inform the public about natural disasters, and react after terrorist attacks? Can technology improve search and rescue missions and data security?

<b>The Future of Search and Rescue, Designed in Munich</b>	
Jörg Böttcher .....	58
<b>Security Politics in a Globalized World</b>	
Carlo Masala and Susanne Fischer .....	66
<b>Security for the Smart, Interconnected World</b>	
Gabi Dreo Rodosek .....	72
Research Centers .....	78
Bibliography .....	80
Imprint .....	82



What will **Future Living** look like? Is there a better way to provide services for elderly citizens, using technology? How can we make the shared spaces that bring our cities to life safe, without making them look like a prison yard? And how can urban authorities revitalize cities, without destroying the demographic mix that defines them?

08

**The Future of Living in an Aging Society**

Helga Pelizäus-Hoffmeister and Kristin Paetzold

14

**Keeping our Cities Safe**

Norbert Gebbeken

20

**Regenerating Inner-city Districts at the Expense of the Urban Mix**

Axel Schaffer







Helga Pelizäus-Hoffmeister and Kristin Paetzold\*

# The Future of Living in an Aging Society

Like many wealthy countries, Germany has an aging population. World-class healthcare and social welfare lead to an increasing life expectancy, which combined with low birth rates means that the proportion of elderly and retired people is steadily increasing. This demographic change has been the driving force in the search for new technological developments to help the elderly in their everyday lives.

This search has involved politicians, scientists and private companies and is based on the hope that the right technological solutions can improve quality of life for the elderly while at the same time reducing the expense of providing vital care and support.

In recent years, there has been something of a boom in products to support the elderly. However, even the most amazing and cost-effective new device is useless if it is not accepted and used by its end users. There have been a number of cases of brilliant technical solutions that have failed to catch on in recent years, but why?

A team of researchers at the Universität der Bundeswehr München are now looking at this question from a new perspective. They analyzed the challenges faced in bringing new devices and technology to elderly users and identified an interesting overall trend: the development of all new devices, including definitions of functionality, has been driven from a purely engineering perspective. This disciplinary orientation means that developments have been driven mainly by technical innovations. However, it also means that concrete application scenarios for future products have not been given enough consideration in developing new devices. This is because the question of concrete application scenarios is investigated not in engineering, but in the social science disciplines such as gerontology, sociology of aging and geriatrics. The everyday practical problems of aging and the associated challenges represent a key research area for scientists in these fields.

» At the start of the development of a product designed to help solve a problem, we pose ourselves a simple question: What is the problem actually about?

The team concluded that an interdisciplinary team with experts from different fields, following a new methodology, would have the best chance of developing new devices that were not just helpful but also accepted and used on a daily basis. The challenge was then to develop a structure for this collaborative team to follow.

### **A Backwards Approach to Put the User First**

**User-oriented product development** is a trend in many areas of development, but the problem is that sociological input comes too late in that process. By then significant product decisions have already been made so that the systems and products are only superficially adapted to user needs. In this approach, the daily challenges the elderly face are neglected.

This is why the new methodology was designed to work backwards. Product development begins with analyzing real, everyday problems to be solved. End users are directly involved in describing the challenges they face, and these challenges are systematically analyzed to identify requirements for product development.

As part of a research project financed by the Federal Ministry of Education and Research and supported by the VDI/VDE-IT, sociologists from the Universität der Bundeswehr München worked with elderly citizens for over a year to develop a research strategy called context-integrated, practice-centered methodology (KPB methodology).

---

#### *Put the User First*

---

*It's important to listen carefully to understand the problems older people face when using modern technology.*





---

*Everyday Life*

---

*Promoting everyday mobility is vital to enable older people to live independently.*

**Practice theory** tells us that technology should not disturb the usual routines of everyday life. Only in this way can the habits and preferences built up over the course of a lifetime be maintained. Humans often resist change, as we are creatures of habit and derive pleasure from our familiar routines. It is vital that this resistance is seen as a natural part of the human experience, and not described as something special to the elderly, a lack of willingness to embrace change or a fear of adopting new technology.

This theoretical foundation leads to a two-step design process. First, identify the everyday practical routines of the end users. Second, design products that can be easily integrated into these routines. Products that make these well-established routines easier will be accepted by users and bring about an increase in their quality of life.

### Looking for Problems – Finding Solutions

The key insight from this research was quite surprising: researchers visited elderly volunteers with reduced mobility at home to find out about the problems they faced in their lives, but instead found that the subjects had already developed a variety of practical strategies to cope with everyday tasks. It is only the outside observers who might call these problems.

At first glance, these strategies might seem trivial or may not be noticed at all, but they demonstrate a remarkable inventiveness as well as the ability to compensate for the difficulties of aging using everyday household objects.

### Five Strategies

In total, five different classes of strategies were identified. **Body techniques** involve the subjects developing different ways to approach everyday tasks that they are no longer able to perform. One interview subject developed a specific routine to climb the stairs. She climbed them at an angle, with both hands on the same railing, counting to herself as she went to set a rhythm that made it easier for her to reach the top.

Some of the subjects used what researchers called **technical upgrades**, including walking sticks and frames, either inside or outside the home.

Another technique observed was training, where subjects performed activities to improve or maintain a physical or mental faculty, from doing exercises in front of the television to playing a memory-boosting computer game (**personal training**).

In cases where there was no way to overcome daily challenges alone, subjects often called on **social support**, from their own family or from professional services.

The final strategy was particularly fascinating, and involved **changing the environment** to meet specific needs. This strategy was often particularly difficult to notice, as the purpose of the changes made was not always obvious. One example was of an interview subject whose hallway was extremely cluttered with furniture to no obvious purpose. Only by visiting the home did researchers see how the participant held on to the furniture for support when walking to the front door.

All these techniques provide more or less successful “responses“ to specific problems, so that you might wonder whether technical support systems are needed at all. However, it is important to remember that even the most creative strategies have their limits. It is precisely at the limits of these strategies that technical solutions can offer a seamless transition into a new phase of everyday life.

An analysis of daily life and routines as well as common coping strategies can provide a wealth of data for engineers to develop functional descriptions of devices and systems to help the elderly. These devices can then be integrated into millions of lives around the country, to provide support and security and become a valuable part of their users’ lives. Only by making these solutions attractive and by making sure they solve real-life problems can we ensure that they help their elderly users, and thereby society as a whole.



**Prof. Dr. Helga Pelizäus-Hoffmeister (left)**

Department of Social Sciences and Public Affairs

*Helga Pelizäus-Hoffmeister is currently Professor of the Sociology of Globalization. She was born in Westphalia and her work focuses on the sociology of aging, aging and technology as well as the sociology of work.*

**Prof. Dr.-Ing. Kristin Paetzold (right)**

Department of Aerospace Engineering

*Kristin Paetzold’s work is focused on products and cognitive systems tailored to different age groups. Her work therefore spans a number of disciplines. In addition to her work as Professor, she is Head of Institute for Technical Product Development.*

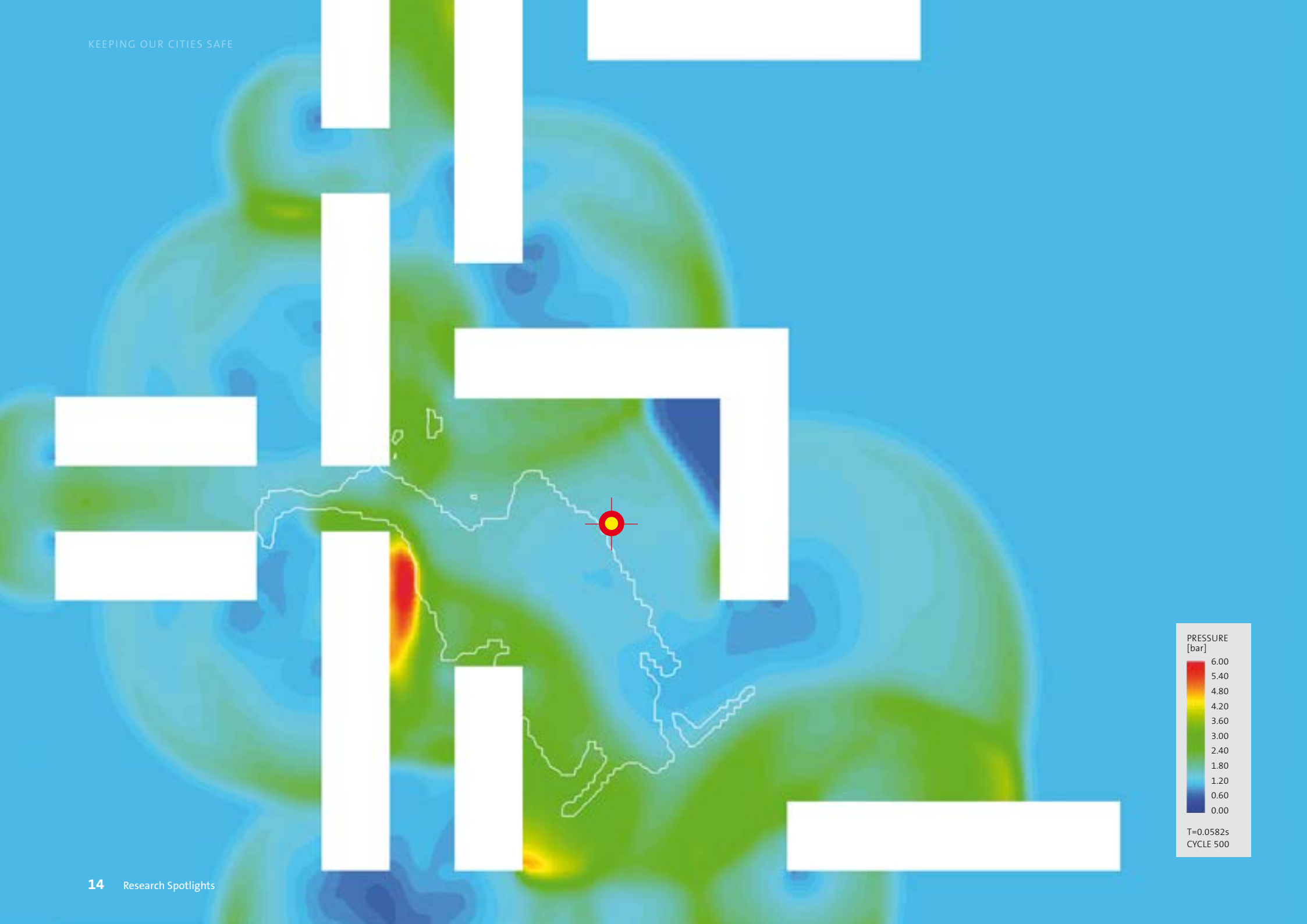

Norbert Gebbeken

# Keeping our Cities Safe

## Infrastructure for Safety and Peace

In recent years, terrorist attacks have increasingly been directed against so-called soft targets rather than against critical infrastructure. In this context, critical infrastructure is defined as buildings and facilities that are essential for a society's survival in case of a catastrophe. Urban areas or public spaces are considered soft targets if a considerable number of fatalities and casualties will be caused by an attack or disaster. Recent examples of terrorist attacks on soft targets in Europe include the metro attacks in Madrid in 2004 and London in 2005, the attack in Oslo in 2011 or in Paris in 2015. These attacks all caused a large number of casualties in unsecured urban areas where people were gathered; waiting for a train or bus, shopping at markets, sitting in bars and restaurants or at events. In order to protect civilians from attacks on soft targets, entirely new and innovative systemic strategies will be required.

---

*Explosion in Urban Environment*

---

*Buildings in white, charge (red circle) placed in meeting square*

## A Variety of Different Threats

Research in this field is currently being carried out by the Federal Emergency Management Agency (FEMA) in America and the Universität der Bundeswehr München, among other institutions. Scientists in Munich are using computational fluid dynamics modeling to simulate propagation and reflection of explosive blast waves in built-up areas. This is a critical question, as the initial blast wave created by an exploding bomb can reflect off buildings, increasing in intensity and travelling around corners to places not even in line of sight with the actual explosion location.

Protective architecture also has to include something to block vehicles from entering sensitive areas. Attackers can use vehicles to carry far heavier bombs, and the vehicle itself can also be part of the attack, ramming through doors and gates and crashing into walls or groups of people.

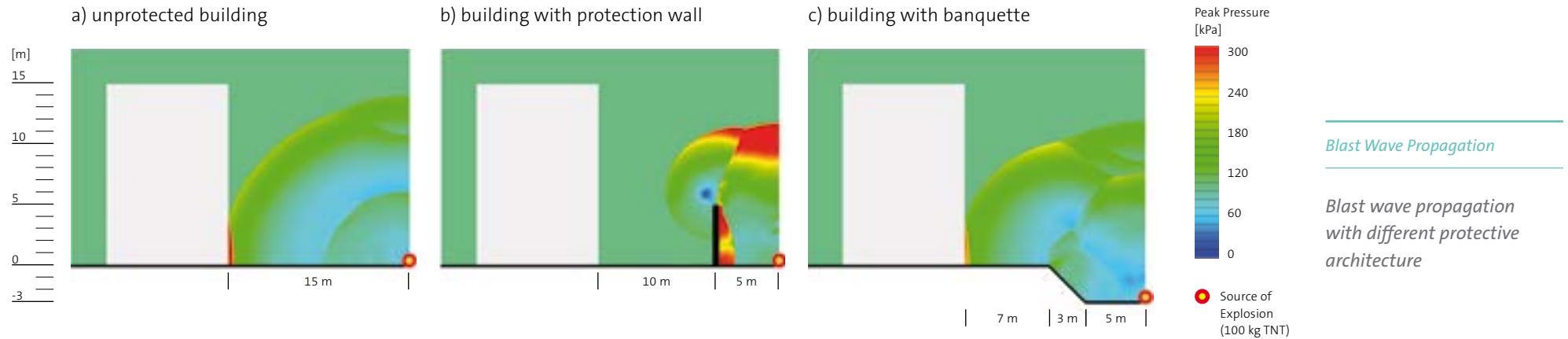

### When is a Wall not a Wall? – A Variety of Protective Options

So in order to protect vulnerable locations from terrorist attacks, walls and barriers must be installed to first, keep the bomb at a maximum distance from citizens by blocking vehicles, and second, deflect or block the blast wave and any flying debris. This is where the future of urban security lies in collaboration between scientists, architects and urban planners to design these precautionary measures in such a way that they offer effective protection without detracting from the comfort and perceived safety of the location. In ideal cases, citizens might not even realize that protective features are there at all.

Terrain modeling can be used to reduce the power of a blast wave or act as a barrier to block vehicles. Sloping ground, ditches or hills deflect and reflect blast waves, or a mixed solution of sloped ground can be combined with a smaller blast wall.

An example of this method can be found in the Minneapolis Courthouse Plaza. The grassy mounds and tree trunks in the forecourt are natural elements, while at the same time acting as safety features to block undesirable access. Non-experts might not recognize these as substantial passive safety elements at all.

Another alternative to a continual, unbroken blast wall is a series of interlinked elements that provide the same protection without breaking up pedestrian flow. Options include interlocking V, T or Y-shaped wall elements. These walls can be made of mixed materials, including concrete or steel sheets, perforated steel sheets or multi-layered materials, to offer more visual variety.

A better solution than boring bollards or unattractive Jersey barriers is a combination of bollards with other protection elements such as planting buckets, trees or solid seating elements, large rocks, street lamps, bus stop areas, or even secured kiosks. Sculptures or artwork are even more inconspicuous, such as the NOGO-barrier designed by Rogers Marvel Architects for the New York City Financial District. These elements serve multiple purposes: as protective elements, sculptures and even playgrounds.



» ... the future of urban security lies in collaboration between scientists, architects and urban planners to design livable and safe urban environments.



---

*A Variety of Protective Options*

---

1 *Minneapolis Courthouse Plaza*

2-3 *Bollards, trees between bollards and different sizes of bollards reduce monotony.*

4-5 *NOGO-barrier, bronze sculptures as seats*

---

---

*Bomb and Collision-proof Curtain*

---

*Curtains made of steel ring meshwork*



» Research in this field is currently being carried out by the *Federal Emergency Management Agency (FEMA)* in America and the *Universität der Bundeswehr München*, among other institutions.

In medieval times, ponds, moats, and marshy land were used to protect the approaches to castles and palaces, while at the same time serving as natural habitats for wildlife or recreational spaces. These kinds of features were the inspiration for another design, the so-called Tiger Trap System (TTS). The TTS is invisible to the untrained eye, consisting as it does of a deformable substrate in a ditch that is covered by a layer of collapsible material strong enough to carry pedestrians and cyclists but that will collapse under heavier loads.

Another visually appealing solution is bomb and collision-proof curtains. The protection capabilities of a fence made of steel ring-meshwork have hardly been studied at all, and further research is needed in this field.



---

*Tiger Trap System*



---

*A Tiger Trap System has a ditch covered with a layer of collapsible material, strong enough for pedestrians and cyclists.*

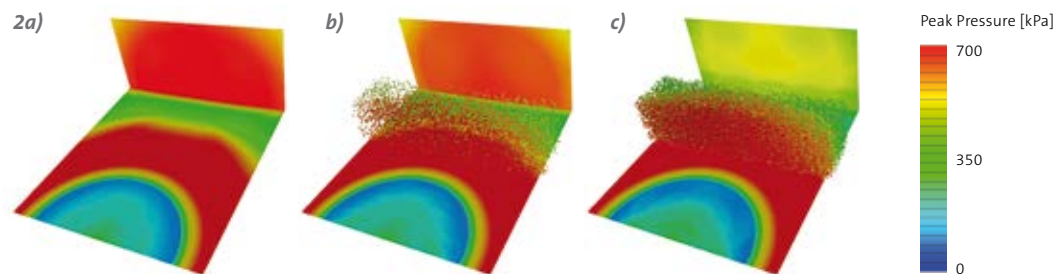

*Protective Elements*

- 1 Hedges and stone baskets can be used as protective elements.
- 2 Simulated blast wave
  - a) unprotected building
  - b) light hedge (1% organic matter by volume)
  - c) thick hedge (5% organic matter by volume)



Trees or hedges and raised planting baskets can also be used defensively. In order to offer protection all year, bushes planted in protective structures should be evergreen plants such as yew or conifers.

In order to test whether hedges are capable of mitigating the effects of blast waves, researchers at the Universität der Bundeswehr München have carried out a number of simulations, showing that a thick hedge can reduce blast intensity by more than 50%. This promising research project is still ongoing. Tests in 2015 and 2016 have validated these numerical predictions.

This type of protective design promises a revolution in urban planning, but the discipline is still very new. We can look forward to many more new developments in years to come, making our cities safer to live in without spoiling the open look and feel of where we live.

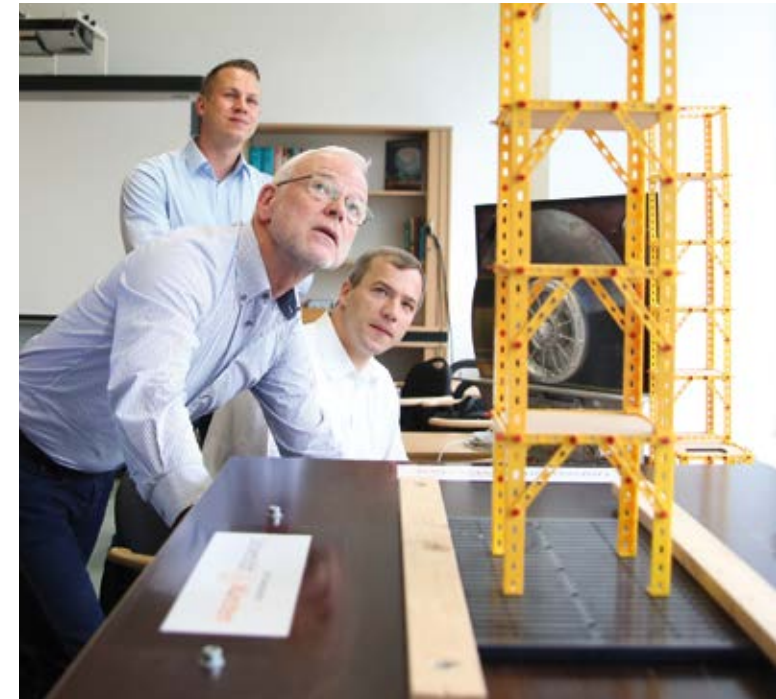

**Prof. Dr.-Ing. Norbert Gebbeken (center)**

Department of Civil Engineering and Environmental Science

*Norbert Gebbeken has been Professor of Structural Engineering at the University for more than 20 years, and is currently Head of Institute for Mechanical and Structural Engineering. A founder member and Spokesman for the research center "Risk, Infrastructure, Security and Conflict" (RISK), he works closely with specialists from other disciplines. Additionally, he is President of the International Association of Protective Structures.*



Axel Schaffer

# Regenerating Inner-city Districts at the Expense of the Urban Mix

Excellent infrastructure, a wide range of not only work, but also leisure activities: City life offers many advantages. But as investment in urban areas increases, real estate prices rise and soon become unaffordable for low-income households, changing the urban mix and offering new challenges for urban authorities.

## Patterns of Urban Development

From the 70s to the mid 90s the population in most of Germany's largest cities decreased. This was mainly due to negative agglomeration effects including pollution and a loss of recreation areas paired with gradually deteriorating infrastructure and was accompanied by an increasing trend of suburbanization. The financial consequences of this pattern for the cities were severe, as the majority of households that left the cities' central areas were middle- and upper-income families, who could afford the relatively high cost of moving their families to the city's green outskirts and surrounding rural areas. In contrast, relatively poorer households generally remained in the inner city, which at that point had comparatively low housing costs.

While this pattern was clear to see, what followed was largely unexpected, as many of the largest cities in Germany have experienced continuous population growth since the mid 90s. This trend has been well documented at city level, but there has been little empirical research at the level of city districts. Our recent study provided new empirical insights by addressing three general assumptions often made in this context:



» Clearly, the renaissance of inner-city areas is not limited to a physical renewal of buildings and infrastructure, but it further transforms the structure of inner-city households, population mix and social life in general.

First, international studies indicate that in the US and UK, urban population growth is largely driven by revitalization projects in inner-city areas (Cox 2015, Helms 2003, Tallon 2007). **We therefore presume that inner-city districts of larger German cities have experienced significantly higher growth rates in recent years compared to other, henceforth outer-city, districts.**

Interestingly enough, urban geographers disagree when asked to identify the major causes of this trend. Some findings indicate that the increases in population can largely be explained by higher birth rates among inner-city population combined with relatively low rents, which particularly attract foreign and young residents. Other findings support the idea that this growth is mainly driven by an ongoing renewal or reconstruction of inner-city districts, partly funded by public programs such as urban development programs launched by the EU, and largely supported by private investment in reconstruction projects. **We follow this line of reasoning and expect that population growth in the inner-city districts is accompanied by rising housing costs.**

**According to the *standard gentrification script* such a change can be expected to jeopardize the former urban ‘mix,’ attracting comparatively rich households and displacing low-income households, many of whom will be foreign nationals** (BBSR 2010, Helms 2003, Keddie and Tonkiss 2010, Laska and Spain 1980).

### Empirical Insights

Statistics for city districts are rather heterogeneous and mostly provided, if at all, directly by the cities. To address the questions outlined above, data for 11 of the 39 cities in Germany with a population of at least 200,000 was analyzed.

The survey analysed data from Berlin, Bremen, Cologne, Düsseldorf, Essen, Karlsruhe, Kiel, Leipzig, Lübeck, Munich and Oberhausen. In the decade that the study looked at between 2004 and 2014, the total population of these 11 cities increased by 4% – compared to a decrease of about 2% for Germany as a whole over the same period. In 2014, these cities had a combined total of 9.1 million inhabitants. This corresponds to about 11% of Germany’s total population.



Type of District and Population Growth, Compared to Local Average

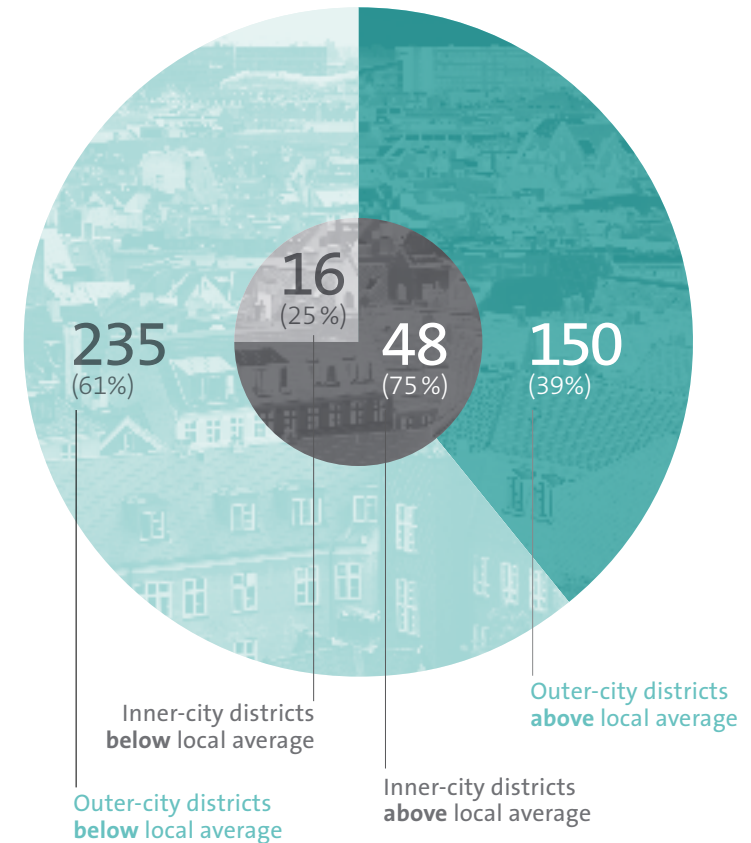

The 449 districts under consideration can be divided into 64 inner-city districts and 385 outer-city districts. 251 of these districts showed below-average growth, 198 grew more than the local average. 75% of inner-city districts showed an above-average population growth, only 39% of outer-city districts grew more than the local average.

Source: Statistical offices of selected cities, KOSTAT (2015)

In total, 449 city districts were analyzed. These can further be subdivided into 64 inner-city districts, which according to the classic conception of cities include the old city center and its surrounding districts (BBSR 2010), and 385 outer-city districts.

To test the *first assumption*, the population trend for each district was compared to the average growth of the city each district is in, and the districts were divided into two groups: those with above-average population growth locally, and those with below-average population growth locally.

Overall, inner-city districts showed larger population growth than outer-city districts, with 75% of inner-city districts experiencing growth above the local average compared to only 39% of outer-city districts. The corresponding chi-square analysis ( $\chi^2=44.74$ ,  $p=0.000$ ), a simple statistical tool to test for the independence of the variables under consideration, further confirms that this result is not coincidental but that the type of district has a highly significant impact on population growth. Thus, the findings clearly confirm the *first assumption*.

Presuming that the revival of the inner-city districts is largely driven by steady public and private investment into formerly dilapidated infrastructure and



Cost of Rent for an 80–120m<sup>2</sup> Apartment, Compared to Local Average

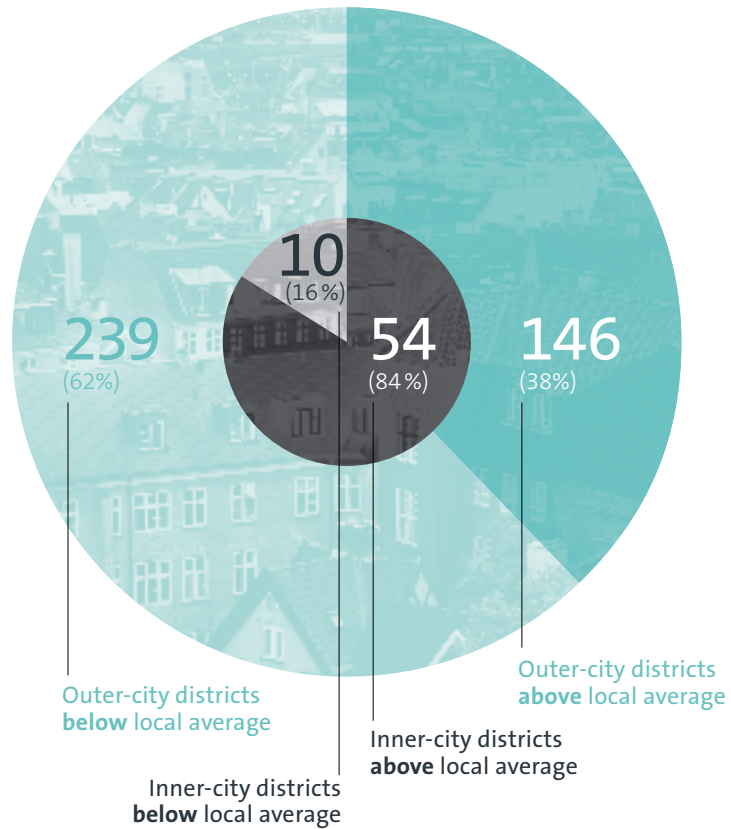

200 of 449 districts had a higher rent price than the local average. 54 of 64 inner-city districts (84%) were more expensive to rent than the local average, whereas only 146 of 385 outer-city districts (slightly less than 38%) were more expensive than the local average.

Source: Statistical offices of selected cities, rent levels partly based on data from the real estate platform Immowelt

Change in Proportion of Foreign Residents, Compared to Local Average

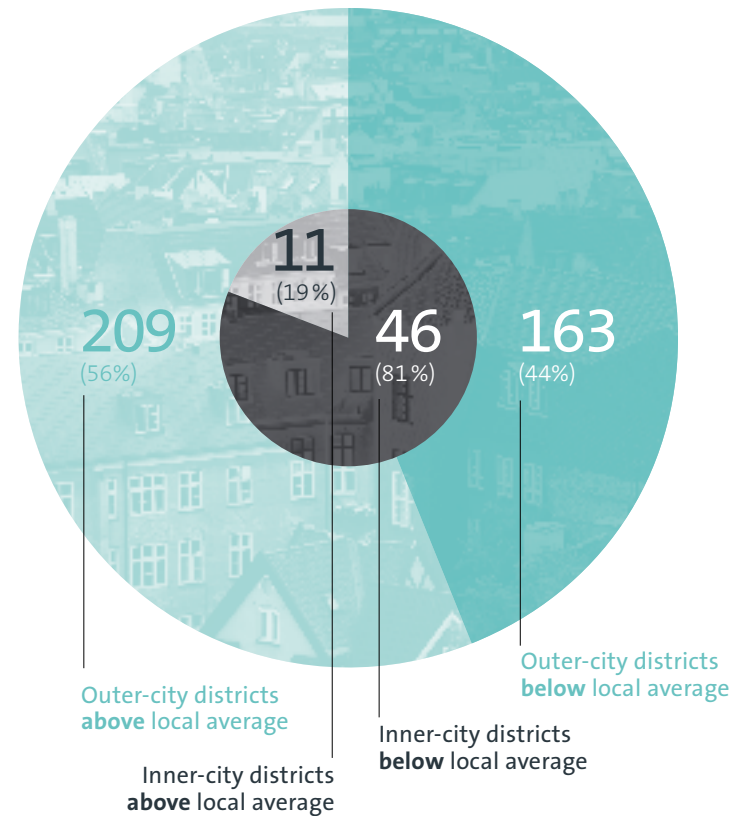

Only 11 of 57 inner-city districts (19%) showed an above-average increase in the proportion of foreign residents. In contrast, 56% of outer-city districts saw an above-average increase in the proportion of foreign residents, compared to all local districts.

Source: Statistical offices of selected cities, KOSTAT (2015)



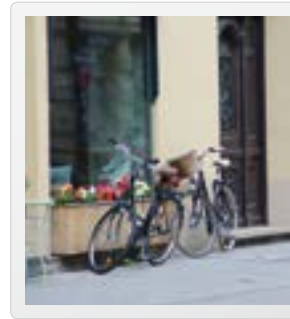
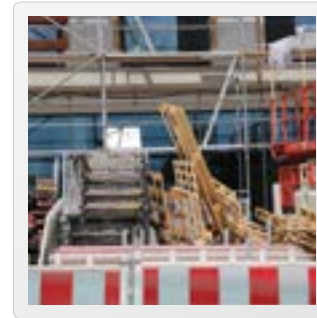

building stock – the line of reasoning we follow in this paper – housing costs can be expected to rise continuously (Guerrieri et al. 2013). Thus, as postulated by the second assumption, rent per square meter should be higher in inner-city homes than in outer-city districts. To validate this assumption, the average rent price for an apartment between 80 and 120 square meters was identified for all 449 districts. Average rental prices per square meter range from around €3 for the cheapest district in Leipzig to almost €21 for the most expensive district in Munich. Based on this data, the rent for each district was compared to the local average in each city, and indeed, 84% of inner-city districts have above-average rental prices, compared to the rest of their city. This is in clear contrast to outer-city districts, where slightly less than 38% cost more than average.

Eventually, and in accordance to our *second assumption*, the corresponding chi-square analysis ( $\chi^2=82.84$ ,  $p=0.000$ ) confirms that inner-city districts show significantly higher rent levels compared to outer-city districts.

Clearly, the renaissance of inner-city areas is not limited to a physical renewal of buildings and infrastructure, but it further transforms the structure of inner-city households, population mix and social life in general. In this context, one serious

*side-effect* is the displacement of lower-income households (e.g. Laska and Spain 1980, Nelson 1988). However, the lack of household income data at district level makes it difficult to validate this point directly. As foreign households have a higher than average chance of being low-income households (Isengard 2002, Goebel and Krause 2013), we use changes in the proportion of foreign residents as a proxy to test the third assumption. If the revitalisation of the inner-city districts entails displacement, this proportion should decline.

Between 2004 and 2014, all the cities under consideration with the exception of Cologne welcomed an increasing proportion of foreign residents, but the same is not true at district level. Instead, internal distribution of foreign residents shifted slightly from inner- to outer-city districts. This means that the proportion of foreign residents in inner-city districts dropped faster or grew less quickly than the corresponding proportion in other districts.

While 81% of inner-city districts showed a below-average increase in the proportion of foreign residents, compared to the rest of their city, only 19% of districts showed an above-average increase. In contrast, 56% of outer-city districts experienced an above-average increase during the same time period.

The corresponding chi-square analysis ( $\chi^2=41.07$ ,  $p=0.000$ ) indicates that, in accordance with the *third assumption*, inner-city districts show significantly lower increases of the share in foreign population compared to outer-city districts.

### A City Plan as a Promising Tool?

In line with the international literature in urban geography, the findings of the study presented here indicate that inner-city districts of larger German cities have, in spite of comparatively high housing costs, developed more dynamically in recent years than outer-city districts. Related gentrification studies further suggest that these districts, generally characterized by the large number of recreation facilities, educational institutions, convenient access to public transport and, after immense investments in reconstruction, high housing quality, have become more and more attractive for high-income households but more and more unaffordable for poor households. The results on the proportion of foreign residents, used as a proxy for lower-income households, validate this trend for the sample of German cities under consideration.

» The idea of looking at the city as an integrated whole, rather than targeting different districts in a piecemeal fashion, makes a city plan of this kind a promising tool.

It should however be noted that empirical findings are preliminary rather than conclusive. Nevertheless, results point to the dilemma for urban politics to attract the private investment necessary for the physical renewal of inner-city districts and, at the same time, to prevent severe consequences for these districts' long-established socio-economic structure, or, as Keddie and Tonkiss (2010) call it, to manage "gentrification without displacement."

One method that municipal authorities are using to try and slow or reverse this trend is to apply regulatory instruments such as the so-called *Mietpreisbremse*, a kind of rent control that sets a limit on how much landlords can increase rents in any given year. It is too early to say if this instrument is a success or failure. However, as new construction projects and major reconstruction are excluded from this rule, programs like this might simply incentivize major reconstruction over small repairs (Deschemeier et al. 2014). Bearing in mind that sale prices are not regulated, property owners might even be tempted to sell rather than rent housing units, which again would discriminate against poor households.

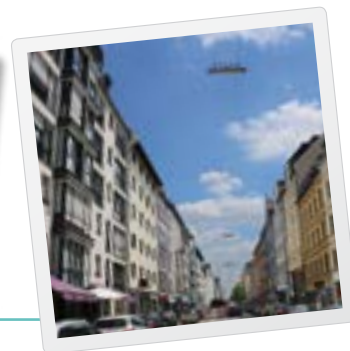

For this reason, some districts use additional regulation to prevent major but arguably unnecessary reconstruction. But as private investors can easily pull their money out and invest in other, less regulated districts or cities, most urban economists are critical of this kind of regulation. In the long run, a strategy like this might also block some necessary reconstruction. At the same time, allowing the free market to decide as was often advocated by neoliberal urban policy in the 1980s and 90s, would only serve to intensify the problem of displacement.

London responded to this dilemma with the so-called *London Plan*. The plan set ambitious targets to rebuild run-down neighborhoods in the inner city in order to meet the demand for housing units at both ends of the income spectrum. The plan did not try to define each individual project – this was basically left to private investors and district councils – but rather set up a joint housing development plan for the city as a whole (Keddie and Tonkiss 2010).

Clearly, a plan designed for one of Europe's largest and most important cities should not be considered a general blueprint for cities in Germany. However, the idea of looking at the city as an integrated whole, rather than targeting different districts in a piecemeal fashion, as well as promoting public-private partnership in the housing sector makes a city plan of this kind a promising tool that could also enrich Germany's urban policy portfolio.

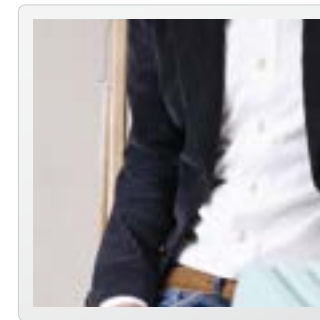

**Prof. Dr. Axel Schaffer**

*Department of Economics and Management*

*Axel Schaffer is Professor for Change and Sustainability, and his main research focus is on regional science, sustainability and climate change economics. At the Institute for the Development of Sustainable Organizations he works on cross-disciplinary projects with the professorships of Human Resource Management, Occupational and Organizational Psychology and International Management.*





The world of mobility has changed so much in the past decades, it is hard to imagine that the biggest changes are yet to come. **Modern Mobility** will change the way we get from A to B. It will change the way we own and use vehicles, change the way our roads and streets look, and lead us into a cleaner and safer future.

30

**Powering the Future of Electric Mobility**

Dieter Gerling

36

**Sharing: The Future of Urban Mobility**

Klaus Bogenberger

42

**Testing for Excellence**

Thomas Kuttner

48

**Autonomous Driving in Unstructured Environments**

Hans-Joachim Wünsche

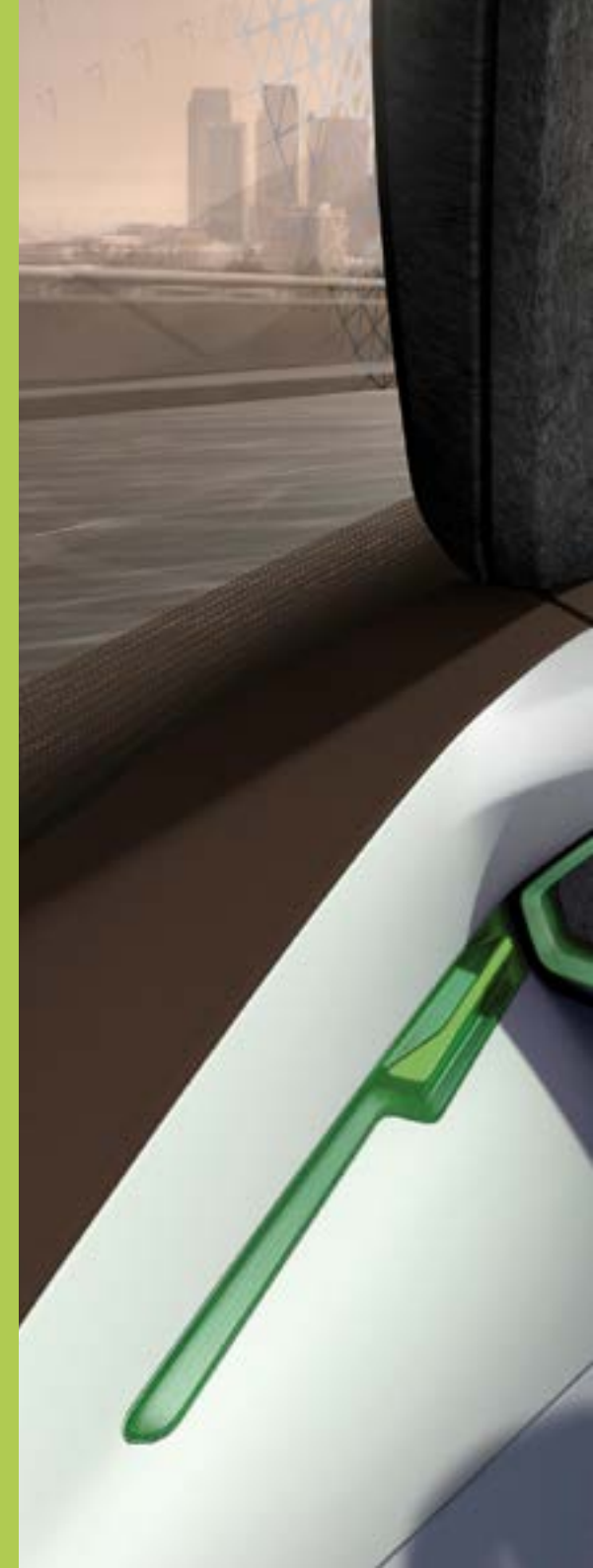





Dieter Gerling

# Powering the Future of Electric Mobility

A new type of electric motor, developed at the Universität der Bundeswehr München, is about to revolutionize the automobile industry. It offers lower production costs and more efficient performance than currently employed motors and will be a significant factor in the coming breakthrough that will see electric cars finally move from niche to mainstream.

There is no question that internal combustion engines have had their day. With a growing acknowledgement of the role of carbon emissions in global warming, governments around the world are putting in place strict emission targets for private vehicles: in China, 120g CO<sub>2</sub>/km from 2020, in Europe, 95g CO<sub>2</sub>/km from 2021, and in the USA, 89g CO<sub>2</sub>/km from 2025. This has driven the push for new drive technologies, but up to now electric vehicles have been the exception rather than the rule. Early models suffered from a very low range and the scarcity of public charging stations meant that these vehicles were just not practical for the average consumer.

## Two Bottlenecks

The two technical bottlenecks in increasing an electric vehicle's range and therefore its practicality are battery and motor. Weight is a vital factor in range and older batteries were heavy, but huge progress has been made in this field. Up to now, there has been less innovation on the side of the motor, but it is equally vital: if the motor can run more efficiently, then the same amount of battery power can take a driver much further. The next generation of electric cars, going on sale in 2017, have an advertised range of 300km per charge, which will be a true game changer. But there is still room for improvement, and new motor technology will be central to this.



The current generation of electric cars typically carry high voltage (HV) batteries, between 250 and 400 V. This has some technical advantages, but requires significant equipment to keep the system safe, including galvanic decoupling and insulation monitoring, which push up the price of the drive system. These vehicles mostly use stators with distributed windings, which have the advantage of a nearly sinusoidal magnetic field in the air gap, but these motors are very complex and expensive to manufacture. Cost-effective mass production as needed for mass-market vehicles is not currently feasible.

A more cost-effective alternative is a motor using tooth-concentrated windings, but these have the disadvantage of a high harmonic content in the magnetic air-gap field, leading to noisy operation and high rotor losses. Advances have been made in cost-effective countermeasures, but this type of motor is still far from ideal.

### **A New Type of Motor**

The search for an electrical motor with better performance that is nevertheless easier to produce led to the development of the ISCAD (Intelligent Stator Cage Drive) solution.

Instead of a stator made with wound copper wire, in this new motor the slots of the stator lamination stack are filled with solid bars of metal. These bars are mounted to a short-circuit ring on one axial stator end and left open on the other.

The bars can be made of aluminum; a significant cost saving versus copper, and the slots can be filled to almost 100%. Aluminum is less conductive than copper, so eddy currents are reduced and the disadvantage in electrical resistance (DC plus AC share) over copper decreases.



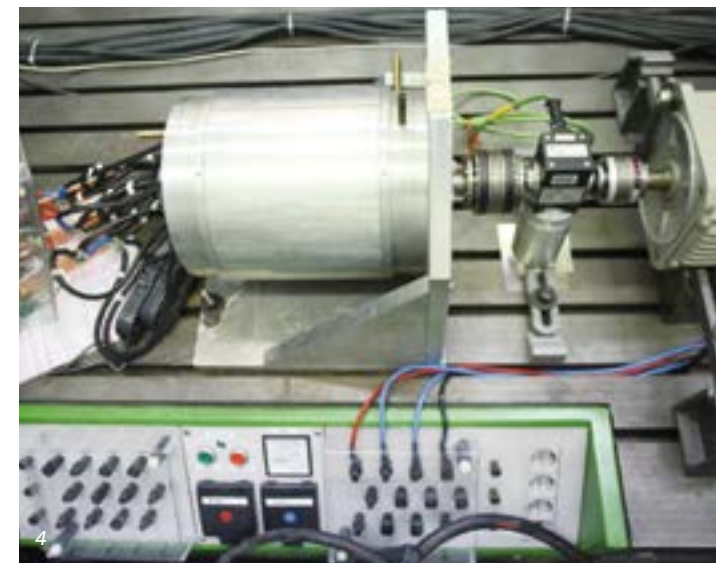
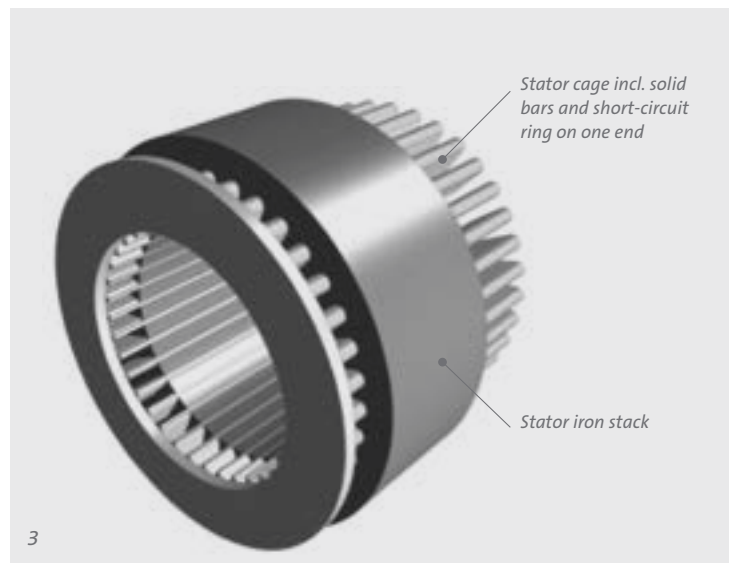

---

*The New Type of Motor*

---

- 1 *Distributed winding stator*
- 2 *Tooth-concentrated winding stator*
- 3 *Instead of wound coils, the ISCAD stator uses solid bars of aluminum.*
- 4–6 *Experimental verification on a test-bench*



## Testing Equipment

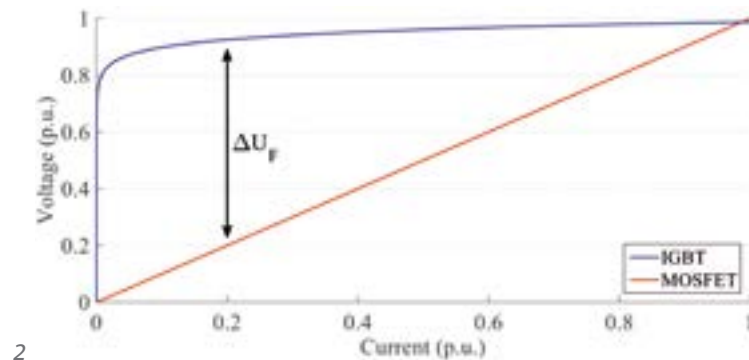

1 High-tech testing equipment in the University lab

2 Under partial load, there is a smaller voltage drop when using MOSFETs, so conduction losses can be significantly decreased.

Only a thin layer of insulation is needed between the iron core and the stator bars, leading to a reduction in thermal insulation and better cooling capabilities, which means a significant increase in the continuous power rating of the motor. This simple construction also reduces the number of possible failure mechanisms, when compared to wound coils.

Because of the low number of turns of the motor, DC voltage can be well below 60 V, representing a huge increase in safety. High voltage means more danger of electric shock. The switch to low voltage also means that low-voltage MOSFETs (metal-oxide-semiconductor field-effect transistor) can be used as switches instead of the high-voltage IGBTs (insulated-gate bipolar transistor) used in conventional electrical motors. And MOSFETs also have significant advantages over IGBTs, including far better efficiency at partial load, bidirectional conduction capability and low switching energy.

## The Perfect Motor for Electric Vehicles

Conventional electric motors usually provide peak efficiency at maximum load, but are inefficient at lower speed and torque. This is one of the problems with designing an efficient electric car, as most driving calls for a lot of low-speed activity, particularly when driving in stop-start city environments. By contrast, ISCAD is able to switch the number of pole pairs in operation and so provide efficient performance under partial load. In addition to this, there are the advantages of the MOSFET inverter.

## Demonstrably Better Performance

To test how large these differences could be, a 60-phase ISCAD motor was compared against a state-of-the-art 3-phase HV motor. Both motors were designed with the same physical dimensions and for the same performance

» Voltage can be well below 60 V, representing a huge increase in safety.

characteristics. The motors were tested according to two industry protocols: the New European Driving Cycle (NEDC) and the driving cycle of the Worldwide harmonized Light vehicles Test Procedures (WLTC). The WLTC in particular is far more dynamic than older test cycles and can be considered a fair approximation of real driving behavior.

In the two different test protocols, the ISCAD motor performed significantly better than the competition: it used 25% less electricity in the NEDC test and 20% less in the WLTC. In a real vehicle, this reduction in consumption not only means a lower cost of driving per kilometer, it can also either be translated into a smaller battery or a longer range.

### **A Solution for Tomorrow**

Within the next few years, electric vehicles will continue to grow in market share. New companies have entered this market, but all the traditional automotive manufacturers are in the game as well, and if your next car is not electric, the one after that probably will be. What is more, there is a good chance that the next electric car you buy will incorporate technology developed at the Universität der Bundeswehr München. ISCAD motors are easy and cost-effective to produce, using only iron and aluminum, and they offer significant additional advantages as well. Running on lower voltage eliminates the danger of a severe electric shock, and the efficiency of the motors means an increase in range as well as a reduction in running expenses.



**Prof. Dr.-Ing. Dieter Gerling**

Department of Electrical Engineering and Information Technology

*Dieter Gerling always analyzes electrical motors as part of a system: the motor, power source and electronic control systems are all assessed at the same time in order to develop an optimal system. As well as being Professor of Electrical Drives and Actuators, he is a Board Member for the research center "Modern Vehicles" (MOVE) and Chairman of Electrical Drives and Actuators (EAA).*

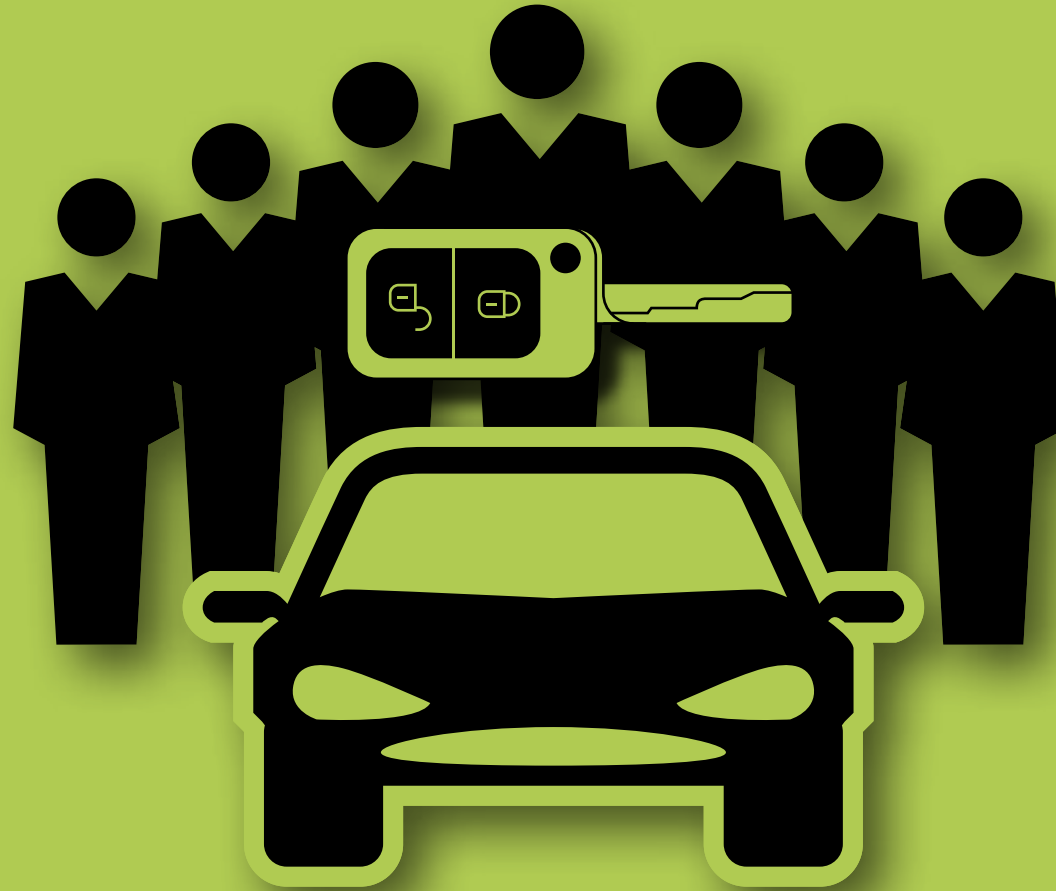

Klaus Bogenberger

# Sharing: The Future of Urban Mobility

For many people, driving is by far the best way to get around. Car owners can get pretty much anywhere they want, quickly and conveniently, and Germany has a very well developed network of roads and streets. However, cars are not without their disadvantages. Around 20% of all carbon emissions in Germany come from transport, and for city dwellers, there are a host of other downsides.

As well as air pollution and noise pollution, space is another problem – cars need not only streets, but filling stations, and parking spaces. In Berlin and Munich, around half of all privately-owned vehicles are parked on the street. Not only is the city paying for part of the operating cost of the vehicle, but parked cars take up much-needed space that could valuably be used for something else.

In the past, these challenges led to changes to the physical infrastructure of a city: new roads and highways, new parking spaces. But recently a new solution has been gaining traction: carsharing. On average, a privately owned vehicle in Germany is used for 76 minutes per day, meaning an idle time of almost 23 hours. Carsharing programs allow multiple users to share a pool of vehicles, reducing costs for the user and idle time of the vehicles: a win-win situation. However, one of the problems of traditional carsharing companies is that users are required to pick up and drop off the vehicles at a rental location.

## **A New Way to Share**

This all changed in 2009 with the entry of so-called free-floating carsharing (FFCS) companies to the transport market, allowing users to find a free vehicle parked nearby and park it anywhere, within a boundary, when they are finished. The same two models are also seen in the bikesharing market, which increased its overall

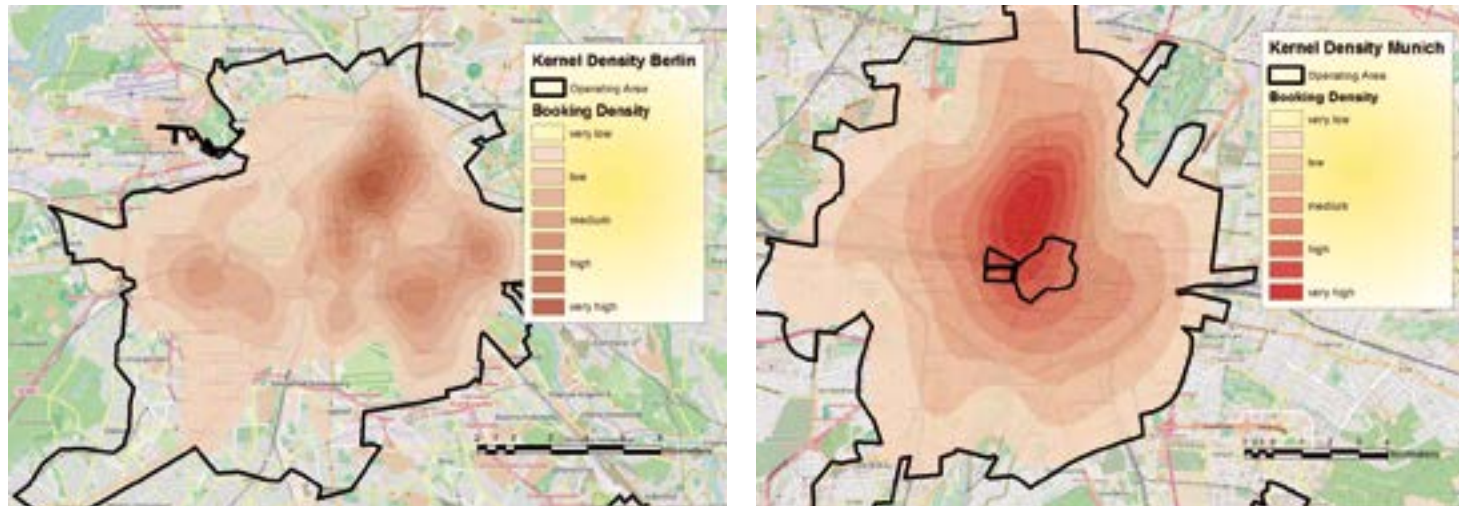

---

### Booking Density

---

*Maps showing booking density of FFCS journey start points in Berlin and Munich*

market share in Munich from 10% in 2002 to 17.4% in 2011. In station-based bikesharing systems, pickup stations are mostly located at major public transport stations, while with free-floating models, a bicycle can be picked up and dropped off anywhere within a set boundary.

A team of researchers at the Institute for Intelligent Transportation Systems conducted research to investigate usage patterns and user behavior in Munich and Berlin. After all, filling cities with eco-friendly bike- and carsharing opportunities does not make any difference if people do not take the opportunity to use these new vehicles. By looking at data collected from bike- and carsharing companies in the two cities in 2013, some interesting patterns became clear.

The data collected was a record of each user journey's start and end point, and the duration of each. First of all, it turns out that carsharing is popular in every part

of the city. Many assumed that the service would be more popular in suburban areas, where public transport is not as dense, but in fact usage was highest in central areas. However, there is a self-reinforcing trend here: a car can only be picked up from the location the last user left it. This means that more journeys begin in locations that lots of people drive to – so-called Points of Interest (POIs). These tend to be areas with a high concentration of residential and professional destinations, i.e. the city center. Data does reinforce one interesting difference between the two cities investigated: Munich has one city center, while Berlin has many local centers with higher density of bookings. The most popular usage area was Prenzlauer Berg.

The same pattern can be seen in free-floating bikesharing in Munich, with more journeys starting and ending in the center. Idle time between different users varied from a few seconds to over a week, but this was shorter in central areas.

# » Carsharing is win-win.

## Rush Hour Sharing

Peak usage times for FFCS, predictably, showed two peaks, one during morning rush hour, and one in the evening after the afternoon rush hour. Usage dips after 10pm, but remains steady until 2am. At the weekend, the morning peak is absent but bookings are strong early in the evening and through the night. Only marginal differences can be seen between the two cities.

Station-based carsharing systems show a completely different usage pattern, where almost all of the bookings are in the daytime. It can be assumed that the differences in usage stem from different strategies in choosing a transportation mode. While FFCS users decide spontaneously which mode of transportation to use, users of station-based carsharing systems tend to plan their trips days or weeks in advance.

About 10% of FFCS trips ended less than 500m from the start point, which can then be defined as round trips. This means that the vast majority of trips are one-way. A significant difference in average journey length can be seen between the two cities: 8.17km in Berlin and 13.16km in Munich.

Profile of FFCS Trip Start Points

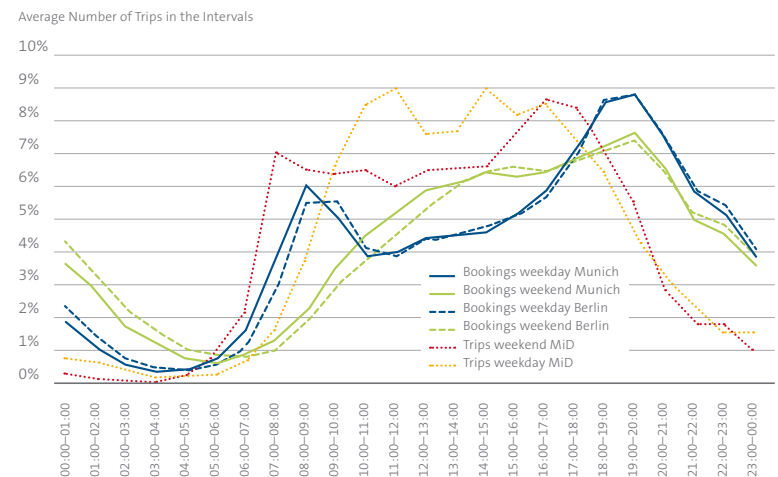

FFCS Trips Over the Week

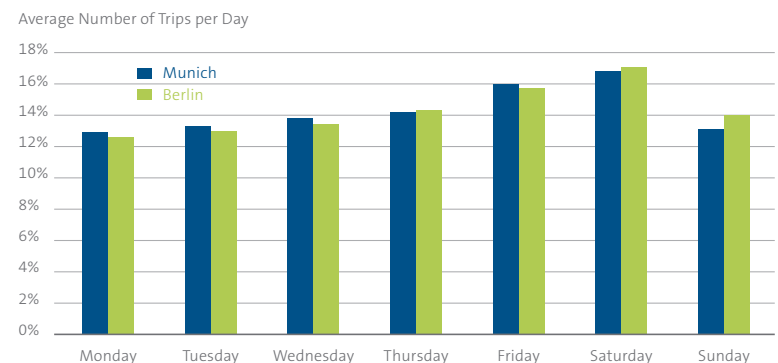

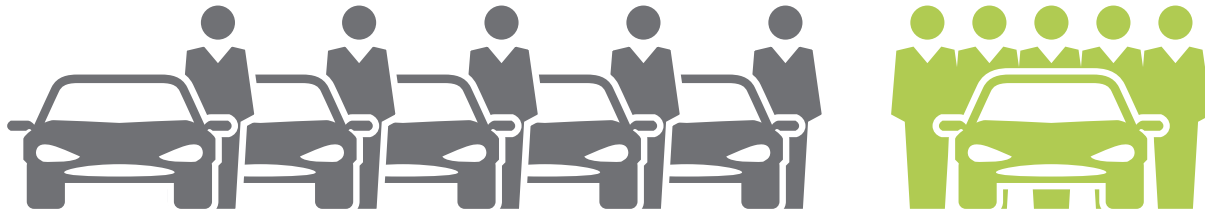

» On average, a privately owned vehicle in Germany is used for 76 minutes per day, meaning an idle time of almost 23 hours.

Purpose of FFCS

Average Number of Trips in the Intervals

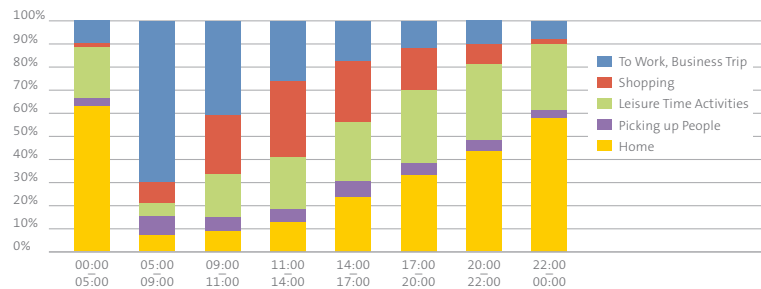

Purpose of Bikesharing Trips (n=420)

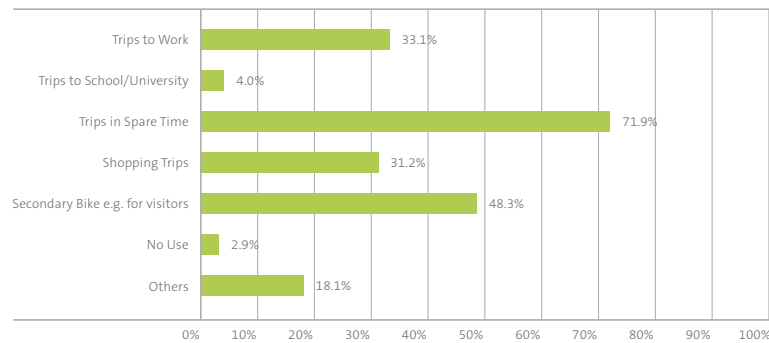

Not Just Where – But Why?

There is a limit to how much this raw data can tell us – with only start and end points to a journey, we can guess the purpose of each trip but not much more. That is why one of the projects in Munich worked with the DriveNow FFCS system to ask users what the purpose of their trip was. Once again, a clear pattern is seen: in the morning, the most common reason for using a car was to get to work, while during the day shopping dominates. In the evening, leisure activities or getting home were the most common reasons given.

A similar trend is also evident for bikesharing. According to surveys, most of the trips are done for leisure time activities followed by business and shopping. Another important reason to use these bicycles is sightseeing as a tourist. Many of the carsharing programs have introduced electric vehicles, and data indicates that users are wary of booking these cars for anything except a short journey. This is more pronounced in Munich, which has significantly fewer charging



stations than Berlin. However, as the range of these vehicles increases and charging stations become more common, we can expect to see vehicles of this type playing an important role in the future.

These results show that bike- and carsharing programs form a vital element of the urban transport mix. Perhaps the most interesting result of all is that more than 11% of all carsharing users, surveyed in 2014, gave up their privately owned car due to their carsharing membership. As these programs grow and become more established, we can hope to see this figure rise, freeing up valuable space in our overcrowded cities. Sharing programs like these are good for the environment, and for the users they are convenient and good value for money. Sharing is definitely here to stay.



---

#### *Electric Scooters*

---

*In addition to cars, public transport, and bicycles, there is another type of mobility solution that is often overlooked in modern mobility systems: electric scooters. While scooters are very common in parts of southern Europe including Italy and Spain as well as in some countries in Asia (e.g. China, Vietnam), this form of mobility is rather unpopular in most of Europe and North America. Nonetheless, with a growing awareness of urban pollution and an increasing lack of space in urban environments, electric scooters can bridge a gap in mobility demand. This is especially true for urban areas with a lack of car parking, congested streets, and average speeds around 30 to 40 km/h, where scooters enable their drivers to be mobile without contributing to pollution through exhaust gases and noise disturbance.*

*In order to explore the potential and limits of eScooter usage in urban areas as well as in sharing systems, the Institute for Intelligent Transportation Systems acquired seven eScooters as part of a federally funded research project. These vehicles are being used in two test phases in order to understand how eScooters are used and what potential barriers have to be overcome in order to use them for everyday mobility. Furthermore, these eScooters will be used to test the acceptance and use of vehicles like this in Mobility Sharing Systems.*



**Prof. Dr.-Ing. Klaus Bogenberger**  
 Department of Civil Engineering and  
 Environmental Science

*Klaus Bogenberger is an expert in electro-mobility and carsharing. He trained as a civil engineer and works on issues in the field of traffic planning and optimization as well as simulation.*



Thomas Kuttner

# Testing for Excellence

It is every driver's worst nightmare: the mechanical failure warning light on your dashboard lights up, and you have to reschedule your whole week around a trip to your local garage. Not only does this problem cost you money in spare parts and labor to repair whatever is wrong, it costs you time. Not to mention worry.

Cars are far more reliable now than they were even ten years ago, and new technology is promising to change the way we travel. Self-driving cars and electrically powered vehicles offer the promise of a safer, greener future, but all of these advances mean that our vehicles are becoming more and more complicated. More components mean that there are more individual things that could go wrong, so how is it that modern vehicles are as safe as they are?

Whenever a mechanical failure occurs in a machine component, whether it is in a private vehicle, a city bus or an enormous mining digger, it passes a cost on to the owner, in both time and money. In the worst possible cases, failure of a single component could cause a vehicle to crash or some further accident, with an even higher cost than the original component fault.

And there are a number of reasons why a component might fail: a manufacturing flaw; overloading or improper use; stress or a minor fracture from a single event or accident; failure to follow maintenance procedures; even corrosion caused by unforeseen environmental factors including dust or seawater.

That's why there are so many procedures in place to make sure this doesn't happen. During development, each component is destructively tested to determine its strength and durability. Parts are then manufactured to a high standard and

» Testing is central to mechanical safety and reliability, and the Department of Mechanical Engineering at the Universität der Bundeswehr München has a state-of-the-art testing facility.

---

#### Factors that Influence Operational Strength

---



*The safety of an individual component is the result of an interaction between a number of different factors: loads (including exceptions or misuse), design, manufacturing and material, and finally maintenance and the environment the part is operating in. Only by assessing all these factors together is it possible to ensure the highest safety standards for components.*

certified for their build quality. Manufacturers issue each part with a service life, a detailed description of proper and improper uses, and a recommended maintenance schedule.

#### Reliability through Testing

Testing is central to mechanical safety and reliability, and the Department of Mechanical Engineering at the Universität der Bundeswehr München has a state-of-the-art testing facility. A system known as a 4-poster test bed allows vehicle components to be tested under realistic conditions, and the system is flexible enough to simulate a number of different loads and conditions. As well as component strength and durability, testing can identify possible vibration issues and the effect of different use profiles on component service life. The data collected in this way can then lead to changes in design to compensate for any problems or weak points, as well as forming the basis for all technical specifications that users will follow.

Flexible testing equipment allows for a wealth of different testing procedures. Components can be tested individually, or in assemblies or complete vehicles. Alternatives can be tested under exactly the same conditions to provide a comparative analysis of different options. In cases where the use profile of a device or machine is to be changed, testing can provide information about how this change will affect reliability, and on the need for possible changes to service intervals or a shorter service life. Repair procedures can be tested to see if they return a damaged component to full operational strength.





---

*Testing is Central to Mechanical Safety and Reliability*

---

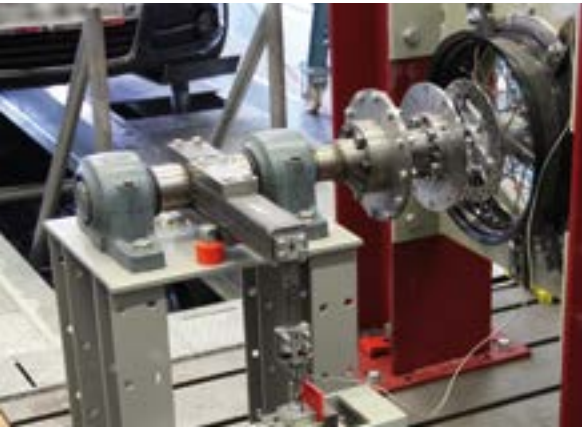
- 1–3 *Testing systems and equipment ensure the highest possible level of component safety.*
- 4 *The working group from left to right: Peter Orth, Dragana Jakovljevic, Stefanie Unseld, Thomas Kuttner*



---

### Testing Equipment

---

*Flexible testing equipment allows for a wealth of different testing procedures.*

## Partnership with Top Companies

The Universität der Bundeswehr München is involved in a number of ongoing projects, in cooperation with top players from the automotive industry. Here are a few examples of the work that is being carried out:

A project in cooperation with Austrian motorcycle manufacturer KTM has been running since 2012 to test **electronically adjustable chassis designs**. Using the 4-poster simulator, the components can be tested at high speed. Non-stop testing for a number of weeks approximates the load across a vehicle's whole operational lifetime, and the benefits of this procedure for the manufacturer are clear. Results are returned quickly enough for the data to be incorporated in the next design phase, and the accuracy of the test setup allows for near perfect repeatability of conditions across a number of different tests. This means that different setups can be compared to a high degree of accuracy. It is also possible to test situations that cannot be recreated on a test track with a human rider – for example, the loss of a stability sensor while on the road.

The laboratory is involved in **developing test procedures** for electrically powered vehicles. Electric vehicles will never become truly mainstream until they can match internal combustion drive systems for cost and range, and while costs have been falling steadily, range is still an issue. Increasing the range of electric cars is a huge challenge for developers and leads to ever-larger battery systems that can weigh up to 200 kilograms and be over 2 meters long. The question is how these heavy modules should be best placed in the vehicle to optimize weight distribution while remaining easy to assemble and avoid impacting driver and passenger comfort. Experience from conventional cars is of little help here – a conventional car battery weighs around 15 kilograms and is mounted with the engine. The Universität der Bundeswehr München is working together with an automobile manufacturer to find the optimum solution to these questions. Different systems are tested in highly repeatable road-realistic situations to evaluate and compare different placement and fastening options.

Another ongoing project is in **testing chassis sensors**. The Bavarian Research Foundation has funded a project to develop a contactless working-load sensor.

## » Different systems are tested in highly repeatable road-realistic situations to evaluate and compare different placement and fastening options.

These systems will be included in the future in auto trailers, and the information they will collect will help to increase driving stability and improve safety by allowing the driver to avoid critical driving conditions. This project is a three-way collaboration, combining the engineering expertise of AL-KO, the sensor technology competence of NCTE AG and the Universität der Bundeswehr München's track record of cutting-edge testing facilities.

With modern equipment, years of experience and the flexibility the laboratory can offer, the Universität der Bundeswehr München is in a position to provide custom-made solutions for testing components and vehicles. What is the benefit of all of this for the customer? Safer cars, lower maintenance costs and improved driving experience are all made possible by testing, helping automobile brands to develop newer and better mobility solutions for the challenges of the future.

The next time you buy a car, you can drive with peace of mind in the knowledge that every tiny part has been tested and refined to improve your safety and comfort. Testing facilities like the one at the Universität der Bundeswehr München are a collaboration between car manufacturers and academic experts who work together every day to make sure that the next generation of vehicles are even safer and more efficient.



### **Prof. Dr.-Ing. Thomas Kuttner**

Department of Mechanical Engineering  
University of Applied Sciences

*Thomas Kuttner studies the causes behind unforeseen damage to machines, as well as what can be done to prevent this from happening. As Professor of Engineering Mechanics, he works on experimental testing procedures, individual solutions for test bed machinery, vibration analysis and functional testing.*

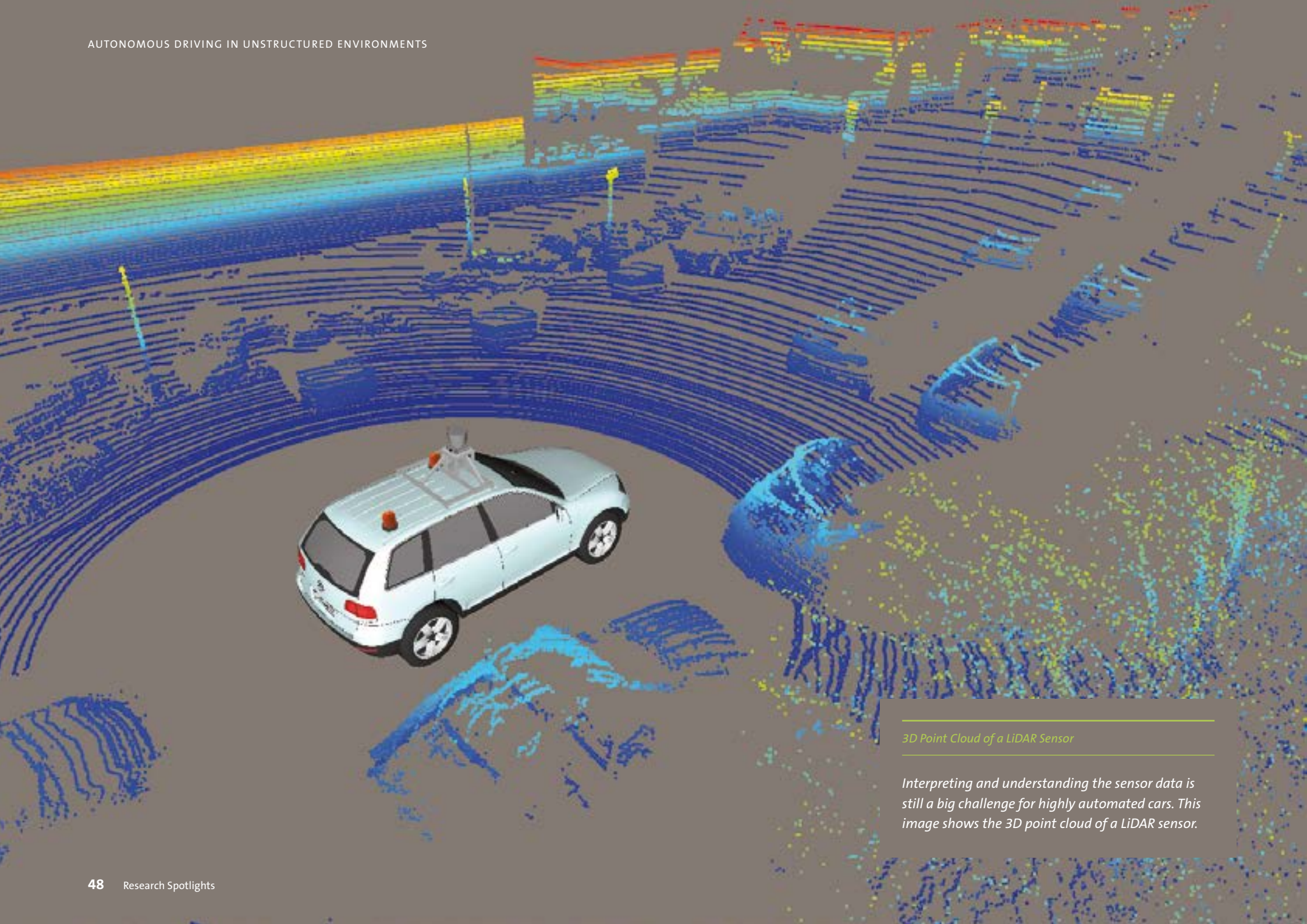

*3D Point Cloud of a LiDAR Sensor*

*Interpreting and understanding the sensor data is still a big challenge for highly automated cars. This image shows the 3D point cloud of a LiDAR sensor.*



Hans-Joachim Wünsche

# Autonomous Driving in Unstructured Environments

Self-driving or autonomous vehicles have been a dream ever since the first cars took to the road. Later, artists depicted the cities of the future with rows of gleaming self-controlling pods bringing citizens from one point to another. Technological advances have changed modern vehicles in many ways, making them safer, more efficient, more comfortable and easier to drive. However, with the exception of a few driver assistance features, the driving experience is still largely unchanged.

A driver uses a steering wheel and pedals to control the car, while paying attention to the environment to avoid accidents and make sure that he gets where he wants to go. All of this is about to change, and much of the pioneering work in this field has been and is being done at the Universität der Bundeswehr München.

## Competition and Development

While the technology employed at the time was rather rudimentary by today's standards, the 2007 DARPA Urban Challenge plus the two preceding DARPA Grand Challenge races were a huge catalyst for worldwide research on autonomous cars. As well as international competitions, real-world driving trials help to identify some of the difficulties autonomous cars will face on the road. During a Daimler road test in 2013, the highly automated car met an ambulance head-on on a narrow road in a small village. The car was expected to clear the road by pulling onto the sidewalk, which of course is normally strictly forbidden. Another tricky situation was when the car later stopped at a crosswalk to let an elderly woman cross the road, and the woman waved the car through. The car was unable to interpret this gesture and simply waited for the woman.

» Real-world driving trials can help to identify some of the difficulties autonomous cars will face on the road.

### Today's Technology

Most researchers agree that it will be another 10 or 20 years before you can send your car off to get a pizza all on its own, but you can already buy cars today that offer some driver assistance features in very structured environments like traffic jams on highways, or for clearly defined parking scenarios.

Daimler just announced their new Mercedes E-class, which will be able to self-drive on Autobahns as long as the white lines are clearly visible, at speeds of up to 210kph. The driver just has to touch the steering wheel every couple of seconds. At speeds below 130kph it will be able to follow the car in front if the white lane markings are not clearly visible, and at speeds below 30kph the driver does not even have to touch the steering wheel. The system also works in principle on county roads, although various testers have found that the system will sometimes switch itself off without warning. So the driver still needs to stay alert, to take control if necessary.

Tesla introduced a self-driving feature for its Tesla S sedan in late 2015, which seemed to require almost no driver interaction. After videos were posted online showing drivers who did not monitor the outside traffic situation at all for several minutes, Tesla had to reduce the functionality in spring 2016 in order to prevent accidents. Two accidents with Tesla cars in 2016, one of them fatal, have dampened the optimism both of some salesmen as well as some users.

According to new international standards, these systems now would be called level 2 autonomous, also known as supervised control. The standards define

**5 different levels** of autonomy: starting from level 0, which describes a car with **no automation features** at all, level 1 is defined as **driver assistance**. This means that individual vehicle controls are partly automated, such as electronic stability control or automatic braking. Level 2, or **partial automation**, describes a vehicle with at least two controls that are automated in parallel, like adaptive cruise control and lane keeping. However, the driver needs to supervise the system at all times to retake control if necessary. In level 3, or **high automation**, the driver no longer needs to permanently supervise the system; in case of a takeover request from the vehicle, the driver has a reasonable time buffer of around 10 seconds before he has to take control. Finally, at level 4 or **full automation**, the vehicle performs all safety-critical functions for the entire trip, with the driver not expected to control the vehicle at any time. Vehicles like this could also operate without a human driver, and in case of a control problem would have to make it to a safe location like a highway shoulder. Some people in the industry even speak about level 5, where a car would not have any manual controls at all.

### Choosing the Right Sensors

Autonomous cars need to carry a suite of sensors and on-board computers. The sensors should be complementary, that is work well together, and also offer redundancy so that the car can continue to operate, at least long enough to get to safety, in case one of the sensors fails on the road. Radar has been used for adaptive cruise control since the late 1990s. One of its benefits is that radar can measure not only the distance but also the speed of other cars in front. However, radar has poor angular resolution, and so early ACC systems did not react to

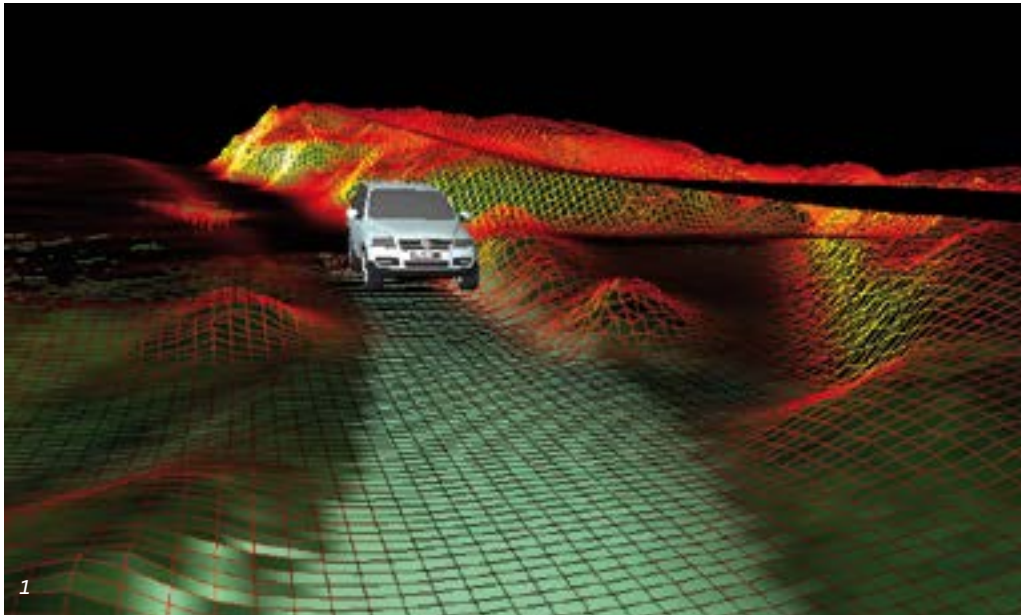

1



2

---

#### *MuCAR-3 Taking Part in Different Trials*

---

- 1 *The fused sensor data of camera and LiDAR enables MuCAR-3 for autonomous navigation during Eurathlon 2013.*
- 2 *Navigating unstructured terrain*
- 3 *The safety driver supervises the operation of an automated convoy system. He will still be required for quite some time.*



3

## The History of TAS (Autonomous Systems Technology)



First Generation 1985 – 2004

### VaMoRs

Test vehicle for autonomous mobility and computer vision (**V**ersuchsfahrzeug für **a**utonome **M**obilität und **R**echnersehen)

*In the 1980s, a team of researchers spearheaded by Prof. E.D. Dickmanns equipped a 5-ton Mercedes-Benz van called VaMoRs with a moveable camera and computers. In 1987, this van completed a world-record drive on the Autobahn just outside Munich, before the new road was opened to public traffic. VaMoRs drove a distance of about 20 km at speeds up to 96 kph. In 1987, a research program called “Prometheus” was launched by the EU, working with car manufacturers and other parties. The researchers convinced Daimler and the Prometheus consortium to drop the inductive vehicle guidance system they intended to use that would have seen cars guided by wires buried in the road, and instead develop a guidance system using cameras.*



Second Generation 1993 – 2004

### VaMP

VaMoRs Passenger Car (**V**aMoRs **P**KW)

*In 1993, a Mercedes-Benz S500 was equipped with cameras, computers and a drive-by-wire system. At the final demonstration of the Prometheus project in 1994, this vehicle performed autonomous lane keeping, adaptive cruise control and autonomous lane change maneuvers at speeds up to 130 kph in public traffic on the 3-lane Autoroute A1 around Paris. A year later the car drove to Denmark on public Autobahns at speeds of up to 175 kph. 95 % of the 1758 km distance was driven autonomously; the longest stretch without human intervention was 66 km. Also this record stood for years. Autonomous vehicles at that time had only camera data to rely on; no GPS or other sensors were available.*



Third Generation since 2005

### MuCAR-3

**M**unich **C**ognitive **A**utonomous **R**obot **C**ar

*In 2004 the Universität der Bundeswehr München created the Institute for Autonomous Systems Technology (TAS) to continue this work. As a test vehicle, a VW Touareg V6 Tdi was equipped with a drive-by-wire system, a movable camera platform, and then in early 2007 with a new high-definition LiDAR sensor, short for “light detection and ranging.” This vehicle is still in service today, and its array of sensors is still growing. Now the focus is on offroad driving.*



» After more than 40 years of computer vision research around the world by countless groups of scientists, the capabilities of even the most sophisticated computer vision systems today are about those of a small pre-school child, maybe 3 or 4 years old.

stationary vehicles, because the resolution was not good enough to differentiate between a stationary vehicle and objects on the side of the road like the pillar of a bridge over a highway.

Cameras, on the other hand, offer very good angular resolution, but no direct way to measure distances. This is why modern ACC systems combine data from radar and cameras to get the benefits of both. Stereo camera systems can overcome some of the limitations of mono cameras, but only at short distances. Model-based monocular camera systems as pioneered at TAS have the potential to see much further ahead and will become increasingly important as autonomous driving speed increases.

Most experts agree that to get to level 4 autonomy a third redundant sensor is required, and one candidate for this is LiDAR. This highly promising new class of sensors is based on laser distance measurements. Modern LiDAR sensors can measure the distances of up to 1.3 million points per second around the vehicle with a rotating sensor head fitted with 64 laser diodes. This dense point cloud then can be analyzed by sophisticated software algorithms to detect not only stationary obstacles but also moving objects like other vehicles or pedestrians. These high-definition sensors offer similar distance precision to radar sensors while at the same time giving angular resolutions coming close to wide-angle cameras. However, at about € 80,000 per sensor, they are currently far too expensive for consumer vehicles. The cost will have to come down to less than € 500 before these sensors will be an option for normal drivers. The first vehicle to be fitted with a simple 4-ray LiDAR sensor with a limited field of view is rumored to be the next Audi A8, to be released in fall 2017.

The TAS team have also tested other sensor systems. Low-light and high-resolution thermal cameras offer enhanced path and intersection recognition as well as recognition of other vehicles, particularly at night. With these sensors MuCAR-3 drives at night in total darkness, i.e. without headlights.

TAS specializes in sensor data fusion, which allows the benefits of different sensor technologies to be combined, increasing robustness. For example, images from color cameras are combined with 3D data from high-resolution LiDAR and thermal images from an infrared camera.

While sensors are absolutely necessary to perceive the environment, the algorithms required to actually understand what is being seen are still a huge challenge. After more than 40 years of computer vision research around the world by countless groups of scientists, the capabilities of even the most sophisticated computer vision systems today are about those of a small pre-school child, maybe 3 or 4 years old. And that is just to detect and classify the objects being seen.

To truly understand the situation those objects create is another issue. Take a normal city intersection: pedestrians, some pushing strollers or on rollerblades or skateboards, cyclists, cars of various shapes and sizes, are all moving and changing lanes, turning and interacting with each other. It's a complex situation to analyze and model, and a challenge for even the fastest modern computers.

This is why computers need help, and most researchers today believe such help will come from high-precision maps. While maps for current navigation systems

---

*Navigating Unstructured Terrain*

---

*Unmanned convoy driving has applications in supply and rescue operations.*



have an accuracy of around 5 to 10 meters, high-precision maps are supposed to allow accuracy to within about 10cm. The car would then not just know what road it's on – it would know exactly which lane it's in, or which part of the intersection, and exactly how far it is to the next turn.

GPS has its limits however, and finds it difficult to offer precision in areas with a lot of “noise” such as urban environments or heavy forest cover. The researchers at TAS have known of those limitations for quite some time, so rather than relying on GPS and precise maps, they are focusing more on perception. If we cannot rely on a map-based system to tell us where the next intersection is and when to turn, the car has to perceive the intersection and recognize exactly when to turn based on this.

At TAS this has resulted in an approach to landmark-based, object-relative navigation, where the vehicle uses maps created on the fly containing navigation-relevant, perceivable objects. In a project for the German department of defense, a method for semi-autonomous multi-truck convoys is being developed, allowing trucks to follow a lead vehicle, even if that vehicle is out of sight. For these scenarios a system is being developed where the lead vehicle observes the environment and recognizes navigation-relevant objects or landscape features. Using a very low bandwidth communication channel, abstract descriptions of these landmarks and their relative position is communicated to the following vehicles, along with the driving choices made by the lead vehicle. An example could be “after about 500 meters, at the 3-way intersection with a tree on the left, I took a right.” As the following vehicles drive autonomously along the road they are now able to recognize these landmarks, allowing them to follow the leader. This approach is much harder to implement in the short term, but in the longer term it will replace methods incorporating high-precision maps.

In other research projects TAS is developing autonomous driving capabilities for an electric delivery vehicle for a global logistics company. A separate team is working with a major German auto manufacturer to investigate the important question regarding which level sensor data should be combined at. At present modern cars employ various sensors, typically from different suppliers, each with its own software. The result is called “object-level” fusion. But what should the car do if the radar sensor says “there is a car 75m in front, probably right of my lane” while the

» Today experts in the field agree that the Universität der Bundeswehr München was one of the global pioneers in autonomous vehicles.

video sensor says “I see a car in my lane about 60m away.” Fusion at the level of raw data would potentially avoid this problem, but faces challenges of its own. An intermediary possibility is “feature-level” fusion, where features like the red rear lights seen in the camera images might be fused with radar reflections of the rear bumper of the car in front to create a coherent object estimate based on this combined data.

Apart from these fundamental technological aspects, there are also legal issues to address. Many countries are only just beginning to issue licenses for autonomous cars. And on the legal side, who is at fault if a car causes an accident while driving itself and the driver did not take over in time? Or how should a self-driving car’s software make difficult ethical choices between multiple harmful outcomes when a crash is unavoidable? Should it crash straight on into the group of 5 people, into the young woman with a stroller on the left or into the two old people on the right? Human drivers have to make such decisions under severe stress and so they might typically only be sued for negligence; however if this decision was programmed into a car’s software, will the programmer of the car or its manufacturer be liable for the fatal outcome of decisions like this?

Initial skepticism on autonomous cars has recently turned into an almost enthusiastic hype. But the two recent accidents of Tesla cars, one of them fatal, have showed the public that much remains to be done before a level 4 car can safely be relied upon, and they have reminded manufacturers to be very cautious in promising features or allowing users to operate those cars outside their design limits. It will be quite some time until the world is ready for level 5 vehicles without a steering wheel or a fleet of self-driving taxis returning empty back to their central station at the end of a day’s work.



**Prof. Dr.-Ing. Hans-Joachim Wünsche**  
Department of Aerospace Engineering

*The long-term goal of the Institute for Autonomous Systems Technology is to equip vehicles with the cognitive capacity to interact intelligently with their environment. Hans-Joachim Wünsche is Head of TAS and Spokesman for the research center Modern Vehicles (MOVE).*



**Security and Crisis Management** is likely to become even more important in the future, both at a local and a national level. As everything becomes digital, how can we keep our data and our devices safe? How can technology be used to help save lives in the event of a fire, bomb attack or natural disaster? What role do governments play in the dialog on security politics?

58

**The Future of Search and Rescue, Designed in Munich**  
Jörg Böttcher

66

**Security Politics in a Globalized World**  
Carlo Masala and Susanne Fischer

72

**Security for the Smart, Interconnected World**  
Gabi Dreo Rodosek









Jörg Böttcher

# The Future of Search and Rescue, Designed in Munich

Security and rescue operations very often have extremely complicated mission profiles. Whether it is the fire service trying to stop a fire from spreading in a building while evacuating inhabitants, emergency response teams trying to help people trapped by a natural disaster, or a large-scale police operation, these events can get very complicated, very quickly.

A large number of people working in a rapidly evolving environment can make it extremely challenging to manage an operation like this, and coordinate all the team members safely and effectively.

In most cases, mission staff only carry simple devices with basic sensory, communication and data capabilities. One example is the hand-held devices the fire service use to measure local gas concentrations, in case of poisonous smoke from a fire. These devices have to be carried by hand to each measuring point, a slow process that can also put a fire fighter's life at risk. For communication, most mission staff use ordinary walkie-talkies. Clearly, there is room for improvement, and a modern technical support system could provide a number of vital services during this type of mission.

## **A Distributed Support System**

But what would a system of this kind look like, and what could it do? Here are some of the features such a system could provide.

- Automatically generate both bird's-eye and POV real-time still pictures and video stream, in the visible or infrared spectrum, based on the individual requirements of team members.
- Automatically generate sensor data including temperature, humidity, gas concentration, and radioactivity, subject to specific requests from team members.

## The LINUS Collaboration

A team of researchers at the Universität der Bundeswehr München worked with partners from the technical field to design and build a distributed support system including both custom software and custom hardware.

The partners were:

- Aschenbrenner Electronics, a manufacturer of rugged computer, camera and display systems
- Cadmic, a producer of drones for civil professional use
- T.CON, a leading SAP partner specializing in integrating ERP (enterprise resource planning) software solutions in production and mobile environments

The project was given the name LINUS, from the German acronym for “air-based, flexible information system to support security and emergency missions,” and was funded by the Bavarian Ministry of Economic Affairs and Media, Energy and Technology. The teams worked together for 2 years and clocked up over 117 man-months. The budget was just under 1 million Euros.

» A large number of people working in a rapidly evolving environment can make it extremely challenging to manage complex operations.

- Calculate real-time overviews of the situation by amalgamating sensor data.
- Provide a robust and easy-to-use communication system for point-to-point and multicast-voice and data communication.
- Maintain a high level of data security for the system and the sensitive data it will generate.

## Drones for the LINUS Cloud

As the LINUS drones would be operating in very harsh and potentially dangerous environments, commercially available machines were not up to the task. The team developed and built a made-to-measure solution, based on a specially developed and extremely strong carbon fiber frame with modified control electronics and firmware. A sensor platform allows cameras or other, mission-specific sensors to be mounted on a revolving frame. An 868-MHz-based radio system sends and receives data, while a separate 5.8 GHz channel transmits video feed.

The drones are in constant contact with the Ground Control Center. In cases where there is no direct radio contact between a specific drone and the control center, other drones can operate as relay stations. The software in the control center automatically distributes the drones in a pattern to optimize radio coverage, and any video and sensor data requested by any of the users can be sent in real time. The Okumura-Hata model, originally developed for cellular radio applications, was modified for the LINUS system and used to estimate the strength of radio contact between drones and the ground station.

### LINUS System

- A complete LINUS system is made up of
- a network of rugged drones that act as sensor and communication platforms, called the LINUS cloud
  - hand-held mobile terminals or “mission assistants” for team members on the ground
  - a portable Ground Control Center
  - optionally, an air control and survey station in the form of a manned flight system



### Mission Assistants

These hand-held units are based on an embedded baseboard with an Intel Core i5-3610ME CPU. The housing consists of an aluminum chassis with integrated cooling structures and an upper shell with touch screen display (1,024 x 768 pixels), a joystick and a few additional keys. The devices also contain GPS receivers and accelerometers to measure compass heading, turning rate and movement. Each unit is powered by a Lilon accumulator. Mission assistants communicate with each other and with the Ground Control Center using a WIFI network and a specific LINUS protocol. Windows Embedded was chosen as the basic OS, as this system allows team members to request sensor and video data from the LINUS cloud, and also supports communications.

### Mobile Ground Control Center

The Ground Control Center is a software package that runs on a commercially available portable computer and has three main parts: The **Management Software** provides a user interface that will typically be used by the officer in charge of the mission. This program collects all sensor and video data from drones in the air as well as specific requests that team members send from their mission assistants. It maintains an overview of the situation as things change and develop over time, and continuously generates new destination coordinates for the drones in order to best fit all current requests. In order to track the locations of drones and team members, the Management Software typically loads map data of the mission location from the Internet.

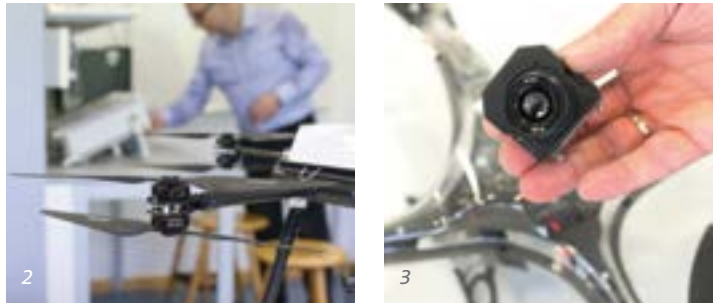

---

### Research Laboratory

---

1–2 Working on the drone in the lab

3 The drones carry small, light infrared cameras.

» The University, meanwhile, continues to research multi-sensor-based, real-time and automatic assessment of mission-relevant data. The goal for the future is to create completely autonomous support systems that can respond to emergency situations with minimal individual human input.

The **Flight Management System (FMS)** controls all the drones, sending them commands and collecting status and sensor data. It receives geographical coordinates from the Management Software, telling it where drones are needed. With this destination data it independently calculates a suitable flight path and prevents collisions with other drones, buildings or terrain.

The third part of the software maintains a **data connection to a remote ERP server** run by the mission authority organization, for example the fire department or a private security company. Within the LINUS project an SAP-based ERP server was chosen as a large number of operators either already work with SAP or are planning to install it. Depending on the specific configuration of the ERP software, a compressed data stream is continuously sent to the mission authority, made up of real-time sensor data, video and other data. The ERP software can then deliver live data from the mission as well as provide analysis of historical mission data. Data transfer is via a mobile Internet connection based on an XML data format such as JSON. On the ERP side, SAP SYBASE ESP (Event Stream Processor) is used as a core platform and Apache Hadoop provides analysis of historical mission data.

---

**Mission Assistant**

---

- 1 Handheld mission assistant
- 2 Mission assistant screenshots
  - a) Sensor and camera data
  - b) Map data
- 3 Ground Control Center software screenshot

1



2a)



b)



3



### Optional Air Control and Survey Station

Researchers installed an adapted version of the Ground Control Center software on the University's research gyrocopter, along with additional LINUX-specific sensor and camera equipment. A system extension like this can be used for missions where an airborne human observer is required, or if heavier sensor equipment is needed, something too heavy for the drones to carry. Simulated missions showed the multiple benefits of a gyrocopter attached to the same LINUX network as the drones.

In particular, the low-speed flight profile of a gyrocopter enables it to stay in contact with the mission location, as well as permitting the use of short or makeshift runways. In contrast to a helicopter, this aircraft is not capable of hovering as its rotors are not powered, but it is significantly cheaper and also safer than a powered-rotor aircraft, and ideal as a platform for an observer and a sensor package in missions like these.

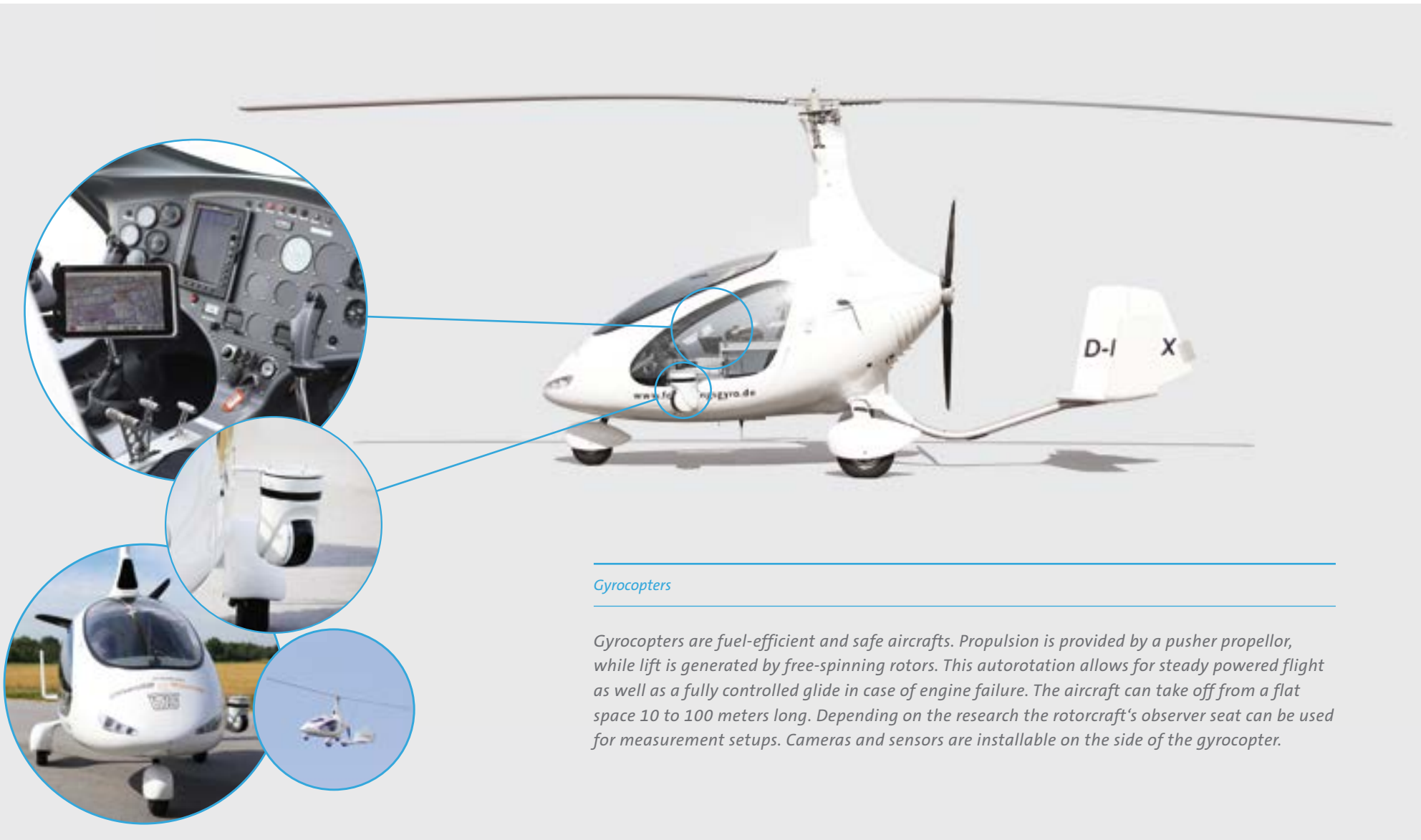

---

### Gyrocopters

---

*Gyrocopters are fuel-efficient and safe aircrafts. Propulsion is provided by a pusher propeller, while lift is generated by free-spinning rotors. This autorotation allows for steady powered flight as well as a fully controlled glide in case of engine failure. The aircraft can take off from a flat space 10 to 100 meters long. Depending on the research the rotorcraft's observer seat can be used for measurement setups. Cameras and sensors are installable on the side of the gyrocopter.*



## The Future: Completely Autonomous Support Systems

The LINUS system contains several sub-systems that allow the system to respond automatically to certain inputs, such as the position of the drones. It also actively filters information, to present only the most relevant data to users on the ground and in the control room, and it connects all the different players in one technical environment with well-defined data interfaces and system functionality.

However, LINUS still requires manual input, for example to request specific information. And, of course, this is just a first prototype system – a demonstration of what is possible in a system that combines state-of-the-art hardware, software and communication technologies. Research is continuing: the companies that worked together with the Universität der Bundeswehr München on the LINUS project are currently starting their own development projects, with the objective of introducing the first LINUS-based components to the market in the near future.

The University, meanwhile, continues to research multi-sensor-based, real-time and automatic assessment of mission-relevant data. The goal for the future is to create completely autonomous support systems that can respond to emergency situations with minimal individual human input. A team of drone fire fighters, entering a burning building to locate residents and lead them to safety while mapping the fire to enable other drones to extinguish it more efficiently. A cloud of drones monitoring a demonstration and passing information to police officers who can then make sure it does not turn into a riot. The future is full of intriguing applications for this technology, to make our world a safer place.



### **Prof. Dr.-Ing. Jörg Böttcher**

Department of Electrical and Computer Engineering  
University of Applied Sciences

*As Professor of Control Engineering and Electronic Measurement Technology, Jörg Böttcher works primarily on automated intelligent technical systems. To this end, his research focuses on a combination of components, software and network technology.*



CH08

2016/07/25 11:15:43

Carlo Masala and Susanne Fischer

# Security Politics in a Globalized World

There is no doubt that our world has changed since the end of the Cold War and the events of September 11, 2001. While technology continues to advance, allowing us to do things that would have seemed impossible just a generation ago, the concept of security has also changed immeasurably. Modern news media gives us access to events all around the world, and our impression of what it means to be secure has changed. Public perceptions of risk and threat are not what they once were.

At the Department of Political Science at the Universität der Bundeswehr München, researchers are working to understand the causes and particularly the consequences of so-called new threats. Their research examines how individuals and agencies respond to these threats at different levels and provides a valuable tool for governments and members of the public to better understand the evolving role of security policy.

New threats include international terrorism, international crime and maritime piracy, and these all have a different character to the classic threat of the old war – an invading army, or even the cold war – a nuclear missile strike. To members of the public, the danger seems ever present, as the targets and timings are unclear. These threats are vague and cross local and national borders, and this in turn has led to previously disparate areas of political activity becoming more interlinked in the search for security. Foreign security policy was at one time completely distinct from domestic security; one a matter for the armed forces and the other for the police. These two areas are now increasingly linked as police and the armed forces coordinate their work to respond to complicated situations. These dynamics pose a challenge for both individual and collective decision-making among politicians, soldiers, states and international organizations that are responsible for security at the national or international level.

» New transnational threats have a different character to the classic threat of the cold war.

### **The Changing Nature of Security**

In the 1950s and 1960s, when academics talked about security, they meant national security and the role of the military in defending a nation against external threats. This changed considerably during the 1980s and 1990s. On the one hand, there was a change in the perception of what it was that should be protected. The concept of security now involves more than just protecting national territory. The United Nations Development Program introduced the concept of human security, while the Copenhagen School discussed the notion of societal security. On the other hand, the list of what counted as a security threat was expanded beyond the realm of military activity, widening the arena of debate to include such issues as environmental security, food security and health security. At the same time the territorial scope of security was shifting, and the old concept of national security was superseded by regional security and global security. During the last ten years the concept of risk has gained particular prominence. Using Ulrich Beck's assumptions on the characteristics of first and second modernity, some scientists have claimed that risks and not threats are what drive national and regional security politics.

### **Maritime Security in a Globalized World**

For coastal regions and nations around the world, the ocean plays a huge role in every aspect of life. Container shipping brings international trade, and considerable oil and gas resources lie under the seabed. Fishing is a major industry, a source of employment, food and valuable fish to trade internationally. At the same time, coasts are magnets for tourists, who bring with them money for hotels, restaurants and local shops.

There are a number of new threats that pose enormous challenges to maritime security. Their effects can cross borders and affect entire regions – for example, tsunamis, climate change and mass migration as well as piracy, illegal fishing and illegal dumping. Accidents at sea can pose a number of dangers to inhabitants and the environment, as the world saw with the Deepwater Horizon incident off the Louisiana coast.

The project Maritime Security in the European Union (MAREU) was funded by the German Maritime Institute to investigate these threats around Europe and

---

### Security Measures

---

*Increased security at train stations and airports, public events and ports with video surveillance and body scanners*



examine patterns in the responses in the political sphere. It has become clear in the past few years that these challenges can no longer be faced by states acting alone. Against this background researchers observed the emergence of new patterns of governance in the maritime space. Agencies and organizations from different levels and sectors are increasingly cooperating to respond to problems and challenges in the marine environment.

Modern piracy is a perfect example of the vague and cross-border character of this new breed of security threat. The Horn of Africa, the coast of Somalia and the Gulf of Guinea have seen a steep increase in piracy in the last decades, and a broad spectrum of security measures have been developed to reduce the number of kidnappings and to enhance security for the global shipping industry. The International Maritime Organization developed Best Management Practices containing information on how to protect ships from being attacked. Several nations have contributed to missions that patrol these high-risk zones, and the topic of stationing armed guards on board ships was hotly debated and, in some countries including Germany, regulated by law.

The conclusion in this field is clear: ignoring these changes in the maritime area in a kind of “sea-blindness” turned out to be the wrong political strategy for Germany and Europe, and there needs to be a substantial concept for maritime security politics. Recent developments in the migrant crisis in the Mediterranean only serve to reinforce this point.

### **National Security after 9/11**

The events of September 11, 2001 in New York and Washington, DC left an indelible impression, not just in the memories of those who lived through the event, but also in political policies around the world. The terrorist attack led to a broad debate about public security and the establishment of new security measures in Germany and several other Western democracies. This debate was further intensified in the years that followed, with deadly attacks in Europe including Madrid, London, Paris and Brussels to name only a few. These events and others made security in public spaces a major political issue, and the discussion included the protection of critical infrastructure such as telecommunication or public transport systems.

» It has become clear in the past few years that these challenges can no longer be faced by states acting alone.

The project Security in Public Space (SIRA) was funded by the Federal Ministry of Education and Research to analyse security measures in civil aviation after 9/11. The results show that subsequent political debate and the development of tighter security measures were heavily influenced by terrorist attacks. In most cases, after a terrorist attack one can observe a fast growth in public debate on security issues which then continues until the introduction of new security measures. Researchers also identified a strong focus on technical solutions to security problems, for example body scanners in airports, or increased use of video surveillance.

The debate on the use of body scanners at German airports is an interesting example of this. After a young man boarded a transatlantic flight in December 2009 with explosives in his underwear, an intense debate on the use of body scanners at airports was carried out in the media and at the political level. Body scanners are a very controversial topic, due to concerns about privacy and health issues, and so a trial was carried out by introducing the new devices at Hamburg airport. Based on this trial, authorities eventually decided not to introduce body scanners at German airports.

Surprisingly, a newer type of body scanner was, in fact, introduced at Frankfurt airport only a few years later, and within a few months several airports had followed suit. The fact that this happened without any public debate shows the complex character of security dynamics and the relationship between security debate in public and security policy decisions.



---

#### Security Measures

---

*Increased security measures to improve safety in civil aviation.*

## Future Developments

Three main aspects stand out from all these research projects. First, the security environment is increasingly determined by what have been described as new threats, offering challenges for individuals and organizations in several sectors and at different levels. Second, by looking at concrete security policy, it becomes obvious that debate about security and the development of security measures is heavily driven by the momentum of large, tragic events and therefore is reactive instead of strategic. Third, it can be observed that technical solutions are often preferred over solutions that take root causes into account.

All of this taken together means that in order to enable a political decision-making process that is based on priorities and strategic thinking, thorough analysis is needed. What kind of threats can be identified and what are the reasons for the emergence of these threats in a globalized world? How can these threats be dealt with strategically? What resources, such as knowledge, financial resources, or technology, are needed to confront the root causes of the threats that have been identified? And last but not least, policy makers need to take into account the norms and values shared by the citizens of Western democracies such as data protection and human rights.

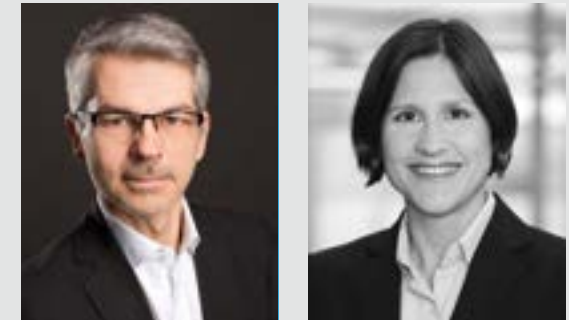

### **Prof. Dr. Carlo Masala**

Department of Social Sciences and Public Affairs

*Carlo Masala contributes to a number of important scientific publications in the fields of security politics and international relations.*

### **Dr. Susanne Fischer**

Department of Social Sciences and Public Affairs

*Susanne Fischer's research is concerned with securitization theory and risk culture. She is Senior Researcher and Lecturer in International Politics.*



---

*Cyber Attack Map*

---

*Prof. Dreo explains the cyber attack map, developed at the Universität der Bundeswehr München.*



Gabi Dreo Rodosek

# Security for the Smart, Interconnected World

Many of us own far more smart devices now than we did even ten years ago. You probably have a smartphone in your pocket right now. Maybe you have a fitness tracker on your wrist. If you recently bought a new car or a new TV set, those are most likely smart devices, offering you more information and features than your previous versions. Perhaps you are even reading the digital version of this magazine, on a tablet or e-reader. And this trend is only going to increase – by 2020, analysts expect 50 billion devices to be connected to the Internet.

But with this increased presence of digital smart devices comes an increasing dependence on them. What would we do if our devices stopped working one day? What would be the effect of a large-scale attack on our digital infrastructure, either as an act of terrorism or an act of war? The increase in connected devices has opened up a plethora of new attack vectors, and the question of how to prevent such an attack is at the heart of the discipline that has come to be known as cyber defence.

Attacks against information and communication technology (ICT) infrastructure are often stealthy and therefore extremely difficult to detect and defend against. In general, the inherently high complexity and sheer number of systems involved are natural enemies of security. Cyber defence must therefore protect all stages of the lifecycle of potentially successful attacks: prevention, detection, and reaction. Researchers at the Universität der Bundeswehr München established the Research Centre Cyber Defence (CODE) in 2013, and are tackling the problems of cyber defence under five main headings:

## **General Cyber Defence**

The past few years have shown that data security is vital, not only for companies but also for public authorities and civil society as a whole. New threats such as ransomware or even smarter attacks targeting a specific person or organisation (advanced persistent threats or APTs) have proved how important enhanced cyber defence measures are. Therefore, several necessary steps have been identified to increase the security of IT systems. It is especially important to detect malicious

» It is especially important to detect malicious behaviour as quickly and as accurately as possible.



behaviour as quickly and as accurately as possible. Researchers at the Universität der Bundeswehr München have developed innovative anomaly detection techniques such as flow analysis in next-generation networks that are based on software-defined networking (SDN) technology. For example, machine-learning algorithms are applied to classify flows by comparing them with a database of malicious and benign categories, and automatically learn.

In cyber security, it is not enough just to identify and block attacks. Although it's very difficult to do, authorities also want to identify the people or organisations responsible for the attacks, so that they can be held accountable for their actions. For this purpose, researchers are developing new techniques in digital forensics and geolocation. They are working to identify how network connections and communication in ICT infrastructures can be analysed to gather data that can later be used as evidence in a court of law.

However, developing new technical solutions alone is not enough to increase security in the digital space. Humans are often the weakest link in the ICT security chain and must be encouraged to develop a higher security awareness and discipline. Research has taken a number of different directions to this end.

### Critical Infrastructure

This research area is focused on protecting critical infrastructure of high importance for our society, including power and gas grids, water supply, the financial sector, and public transportation as well as the communication infrastructure that is used for financial services and also the Internet itself. After all, the Internet has become vital for today's economy and society.

A simple yet devastating way to attack such infrastructure is a distributed denial of service (DDoS) attack. In recent years, the number of DDoS attacks against critical infrastructure has significantly increased. One reason for this increase is that it has become easier than ever before to carry out an attack. Only a few years ago, an attack of this kind required advanced skills in several fields, such as computer programming and networking. Today, the only things a would-be attacker needs are a web browser and a little bit of money: DDoS can be bought online as a service, allowing any amateur to cheaply rent a botnet consisting of thousands of malware-infected machines in order to attack any target they choose. As an increasing amount of critical infrastructure depends on the



---

### High Security Research Lab

---

*The High Security Research Lab is equipped with modern and high tech equipment and provides an outstanding teaching and research environment for students and scientists.*

Internet, proactive DDoS and botnet detection and defence techniques are an important focus of research.

Beyond such low-cost and easy-to-use attack services, there are also more sophisticated forms of attack. Probably the best-known and most sophisticated attack against critical infrastructure of its time was Stuxnet, which was attributed to state-sponsored intelligence services and was created to sabotage Iranian nuclear power plants. Detecting and analysing or even preventing the success of such hand-crafted malware, dedicated to a single attack, is one of the most challenging areas of security research today.

A core problem in protecting critical infrastructure is the imbalance between the systems on either side of the conflict. Hardware and software components used in large infrastructure networks are rather static and usually in service for years, if not decades. On the other side of the battlefield, malware is highly dynamic and new versions can be released on a daily basis. For this reason, innovative solutions that provide highly dynamic detection and defence capabilities in long-serving critical infrastructure systems are gaining increasing research attention.

### Smart Data

Our digital devices generate, transmit, and process a huge amount of data, and this is increasing rapidly due to the tremendous growth of networks and the Internet, the omnipresence of social media, new technologies and paradigms like machine-to-machine communication and the Internet of Things. In many ways, this data is the raw material of the digital world, but efficient cyber defence is only possible if relevant information can be extracted from the huge volume of raw data. For this reason, an increasing amount of research is being conducted into how to turn Big Data into Smart Data.

Research at the Universität der Bundeswehr München is focused on Smart Data analytics, based on data collected from various sources including computer and telecommunication networks, social media, finance, healthcare, and other inter-connected systems. Researchers evaluate different data sources to identify the reliability and usability of structured and unstructured data for advanced processing, and to determine which public information sources are suitable. Developing intelligent algorithms for data analysis and to increase the quality of

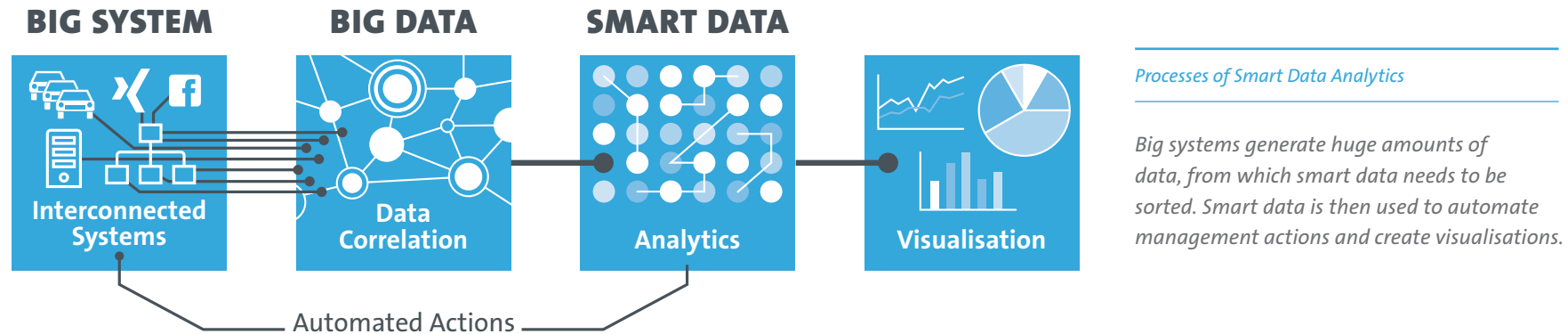

data and information is a core task of all research activities. Refinement includes creating a clearly arranged visualisation of analysis results and a real-time cyber situation map, to enable more agile and comprehensive decision-making processes. Visualisation is not only a technique for presenting relevant results, but also an opportunity to improve human-computer interaction and usability. Furthermore, effective and dynamic detection of known and hitherto unknown cyber threats and malicious behaviour leads to the possibility of automated reactions and therefore towards building blocks that could be used in an automated cyber defence system.

## Mobile Security

This research field investigates specific threats and security measures for stand-alone as well as embedded mobile devices, such as smartphones and computer systems in connected cars. Today, mobile systems are no longer isolated but connected to each other as well as to the Internet, either directly or via other devices. With the increasing prevalence of mobile systems, the impact of an attack on local and global mobile networks and communication data has skyrocketed.

On the one hand, connecting different devices together increases functionality, comfort, and usability, but these developments present new security challenges. At the Universität der Bundeswehr München, mobile security research activities focus on car-to-car as well as car-to-environment communication. For example, protecting driver assistance systems in cars against malicious manipulation of data delivered by internal and external sensors is obviously not just an ICT security question, but also a safety issue for the car's passengers and the environment.

## E-Health

With the rise of wearable devices that collect and analyse health data in people's day-to-day lives, a vast amount of sensor data is becoming available. In many cases, this data contains hidden information about medical conditions and health issues. Once important aspects like the protection of personal rights and personal data security have been adequately resolved, data science will support medical research by analysing this data, to the benefit of public health. For example, a framework that supports early warning systems for a number of health conditions has the potential to increase life expectancy among users. Trends that are indicative

» In recent years, the number of DDoS attacks against critical infrastructure has significantly increased.

of certain illnesses can be correlated with every conceivable aspect of other medical information or with external information like regional aspects or other characteristics of the affected population. Outbreak detection of infectious diseases and immediate information about regional distribution patterns could enable governments to react quickly, minimising or preventing large-scale epidemics.

Researchers at the Universität der Bundeswehr München worked together with the Medical Service Headquarters to develop a central platform for information management in the area of Medical Intelligence (MedIntel). The requirements for such a platform are highly complex. Every day new disease outbreaks and other medically relevant messages are recorded and processed. This data is then enriched with location information so that it can be associated with current and planned operations. In addition to information from open sources, knowledge gathered by the forces on the ground is also incorporated into the system. As part of the research project RAAPIT (Routine Analysis, Assessment and Publishing Medical Intelligence Tool), a prototype system that implements these requirements was developed.



**Prof. Dr. Gabi Dreo Rodosek**

Department of Computer Science

*Gabi Dreo holds the Chair for Communication Systems and Network Security and is Director of the research centre CODE. Her research interests include cyber security, management of the future Internet, Internet of Things/Data/Service, Inter-Clouds, intrusion detection of smart attacks, Software-Defined Networking, and integrated IT management.*

To align to standard terminology and institution names, British English has been applied throughout this article.

# Research Centers

It is of crucial importance for the further development of a university to promote its research reputation. The Universität der Bundeswehr München has established four Research Centers – CODE, MIRA, MOVE and RISK – in order to focus on its unique research expertise. The Research Centers join existing cooperation programs within the University and serve as central points of contact for researchers from inside the University and outside.



CODE is currently developing into the only center for cyber security of its kind in Germany and is strongly supported by the Federal Ministry of Defence. Since secure IT infrastructure is key to a digital, networked society, research and innovation are focused on areas including network security, connected car and plane technology, big data analytics, critical infrastructure and e-health. The center is staffed by members of the Department of Computer Science, which is currently going through a period of significant growth.



MIRA represents a synthesis of research in aerospace engineering and space exploration and exploitation. The Universität der Bundeswehr München has particularly distinguished itself through research involved in developing the Galileo system and, in the field of aerospace engineering, is engaged in a number of international projects in space exploration, most recently on the comet 67P/Churyumov-Gerasimenko. These projects are conducted by scientists from the Department of Aerospace Engineering, but MIRA also cooperates with the German Aerospace Center (DLR), the Technical University Munich (TUM) and Bauhaus Luftfahrt within the research association Munich Aerospace.

The common goal of the research centers is to make the research strengths of the University visible and position them in the national and international research landscape. Further goals vary from research center to research center, and include promoting young scientists and user consultancy as well as establishing and extending external research cooperation programs.



**CODE** – Cyber Defence



**MIRA** – Munich Integrated Research on Aerospace



**MOVE** – Modern Vehicles



**RISK** – Risk, Infrastructure, Security and Conflict



MOVE is a research center that, in the broadest sense, focuses on technological development within automotive research. It brings together scientists engaging in research on autonomous vehicles, electric and hybrid motors, driver assistance systems, as well as traffic. Members are from the Departments of Aerospace Engineering (LRT), Electrical Engineering and Information Technology (EIT), Civil Engineering and Environmental Science (BAU), and Mechanical Engineering (MB).



RISK is a center that directly connects research in the field of social sciences with technological research. Researchers from the Department of Civil and Environmental Engineering investigate the impacts of unforeseeable events, such as events of climate change including flooding, torrential rains, severe storms or earthquakes, but also man-made disasters such as terrorist attacks. At the same time, scientists from the Department of Social Sciences and Public Affairs look at social implications and societal effects caused by such events.

## Future Living

### The Future of Living in an Aging Society

Helga Pelizäus-Hoffmeister and Kristin Paetzold

Birken, T.; Pelizäus-Hoffmeister, H.; Schweiger, P.: Judging the Desirability and Acceptance of Assistance Systems for the Elderly – Lessons Learned with a Fieldwork Approach, in Proceedings of the 49th Annual Hawaii International Conference on System Sciences HICSS 2016, Los Alamitos et al., IEEE computer society, p. 579–588, 2016.

Paetzold, K.; Pelizäus-Hoffmeister, H.; Walter, J.: An Approach to include the Life Situation of Elderly People in Product Development. In: Marjanovic, D.; Culley, S.; Lindemann, U.; McAloone, T.; Weber, C. (Hrsg.): International Design Conference - Design 2016, Dubrovnik - Croatia, May 2016, zur Veröffentlichung angenommen.

Pongratz, H., Birken, T. (2015): Praktikanz als Zieldimension anwendungsorientierter Forschung [40 Absätze], in Forum qualitative Sozialforschung, Vol. 16(3), Art. 9 URL: <http://nbn-ressolving.de/urn:nbn:de:0114-fqs150396>.

### Keeping our Cities Safe

Norbert Gebbeken

Barakat, M.A.; Hetherington, J.G.: New architectural forms to reduce the effects of blast waves and fragments on structures. Structures Under Shock and Impact V, p. 53–62, 1998.

Burger, U.: Impactverhalten von hybriden Verbundwerkstoffen mit metallischem Ringgeflecht. Dissertation, TU Berlin, 2009.

Federal Emergency Management Agency. FEMA 426: Reference Manual to Mitigate Potential Terrorist Attacks Against Buildings, 2003.

Federal Emergency Management Agency. FEMA 430: Site and Urban Design for Security – Guidance Against Potential Terrorist Attacks, 2007.

Gebbeken, N.; Döge, T.: Der Reflexionsfaktor bei der senkrechten Reflexion von Luftstoßwellen an starren und an nachgiebigen Materialien. Bauingenieur, 81 (11) 496–503, 2006.

Gebbeken, N.; Döge T.: Vom Explosionsszenario zur Bemessungslast. Der Prüflingenieur, 29, 42–52, Okt. 2006.

Gebbeken, N.; Döge, T.: Explosion Protection – Architectural Design, Urban Planning and Landscape Planning. Int. J. of Protective Structures, Vol. 1(1): p. 1–22, 2010.

Gebbeken, N. und Ruppert, M.: A new material model for concrete in high-dynamic hydrocode simulations. Archive of Applied Mechanics, 70, 463–478, 2000.

Gebbeken, N.; Teich, M.: Zur Sicherheit kritischer Infrastrukturen unter außergewöhnlichen multiplen Gefährdungen. Berlin, Ernst & Sohn Bautechnik 88 (2011) Heft 10, 663–667.

Hartmann, T.; Pietzsch, A.; Gebbeken, N.: A Hydrocode Material Model for Concrete. Int. J. of Protective Structures, Vol. 1(4), p. 443–468, 2010.

Larcher, M.; Casadei, F.: Explosions in Complex Geometries. Int. J. of Protective Structures, Vol. 1(2), p. 169–196, 2010.

Lenk, O.: Charakterisierung und Anwendung von flächig periodischen Metall-Ringgeflechten. Dissertation, TU Cottbus, 2009.

Teich, M.; Gebbeken, N.; Larcher, M.: Cable net facades subjected to explosion loads. In: Int. Symposium on the Application of Architectural Glass. Engineering and architectural design of glass. Munich, Germany, 2010.

Teich, M.; Larcher, M.; Gebbeken, N.: Hazard mitigation strategies for windows and glazing systems subjected to extreme loads. Int. Conf. glasstec. Düsseldorf, Germany, 2010.

### Regenerating of Inner-city Districts at the Expense of the Urban Mix Axel Schaffer

BBSR (Bundesinstitut für Bau-, Stadt- und Raumforschung), 2010, Fokus Innenstadt. Aspekte innerstädtischer Bevölkerungsentwicklung, BBSR-Berichte KOMPAKT, Bonn.

Cox W., 2015, Growth concentrated in most suburbanized core cities, newgeography: <http://www.newgeography.com/content/004948-growth-concentrated-most-suburbanized-core-cities>.

Deschemeier P., Haas H., Hude M., Voigtländer M., 2014, Die Folgen der Mietpreisbremse. Eine Analyse am Beispiel der Wohnungsmärkte in Köln und Berlin, IW policy paper 17/2004, Institut der deutschen Wirtschaft, Köln.

Goebel J., Krause P., 2013, Armut in verschiedenen Bevölkerungsgruppen, Datenreport 2013, Bundeszentrale für politische Bildung, <http://www.bpb.de/nachschlagen/datenreport-2013/private-haushalte/173520/armut-in-verschiedenen-bevoelkerungsgruppen>.

Guerrieri V., Hartley D., Hurst E., 2013, Endogenous gentrification and housing price dynamics, Journal of Public Economics 100: 45–60.

Helms A. C., 2003, Understanding gentrification: an empirical analysis of the determinants of urban housing renovation, Journal of Urban Economics 54: 474–498.

Isengard B., 2002, Machbarkeitsstudie zur Erhebung einkommensschwacher und einkommensstarker Haushalte im Sozio-Oekonomischen Panel (SOEP), DIW, Berlin.

Keddie J., Tonkiss F., 2010, The market and the plan: Housing, urban renewal and socio-economic change in London, City, Culture and Society 1: 57–67.

KOSTAT, 2015, KOSIS Kommunalstatistik, <http://www.staedtestatistik.de/173.html>.

Laska S., Spain D. (Eds), 1980, Back to the city: Issues in Neighborhood Renovation, Pergamon, Elmsford, NY.

Lees L., 2008, Gentrification and social mixing: Towards an inclusive Urban Renaissance?, Urban Studies 45(2): 2449–2470.

Nelson K., 1988, Gentrification and distressed cities, Univ. of Wisconsin Press, Madison.

ODPM (Office of the Deputy Prime Minister), 2005, Affordability targets: Implications for housing supply, ODPM, London.

Tallon A. R., 2007, Bristol, Cities 24(1): 74–88.



## Modern Mobility

### Powering the Future of Electric Mobility

Dieter Gerling

People's Republic of China. Ministry of Industry and Information Technology, "GB 27999-2014: Fuel consumption evaluation methods and targets for passenger cars," 2014.

The European Parliament and the Council of the European Union, "Regulation (EC) No 443/2009 of the European Parliament and of the Council of 23 April 2009 setting emission performance standards for new passenger cars as part of the Community's integrated approach to reduce CO<sub>2</sub> emissions from light-duty vehicles," 2009.

The European Parliament and the Council of the European Union, "Regulation (EU) No 333/2014 of the European Parliament and of the Council of 11 March 2014 amending Regulation (EC) No 443/2009 to define the modalities for reaching the 2020 target to reduce CO<sub>2</sub> emissions from new passenger cars," 2014.

United States. Environmental Protection Agency and National Highway Traffic Safety Administration, "40 CFR Parts 85, 86, and 600; 49 CFR Parts 523, 531, 533. et al. and 600: 2017 and Later Model Year Light-Duty Vehicle Greenhouse Gas Emissions and Corporate Average Fuel Economy Standards; Final Rule," 2012.

Engstle, A., Deiml, M., Schlecker, M., and Angermaier, A., "Development of an 800-V Electric Car with Rear-Wheel Drive," *ATZ Worldwide* 114(7-8):40-44, 2012, doi:10.1007/s38311-012-0191-z.

<http://www.porsche.com/microsite/mission-e/germany.aspx#/conclusion>, downloaded on 11.03.2016.

Dajaku, G.; Gerling, D.: "A Novel 12-Teeth/10-Poles PM Machine with Flux Barriers in Stator Yoke", 2012 International Conference on Electrical Machines (ICEM), Marseille, France.

Dajaku, G.; Gerling, D.: "Analysis of Different PM Machines with Concentrated Windings and Flux Barriers in Stator Core", 2014 International Conference on Electrical Machines (ICEM), Berlin, Germany.

Dajaku, G.; Gerling, D.: "A Novel Tooth Concentrated Winding with Low Space Harmonic Contents", 2013 IEEE International Electric Machines and Drives Conference (IEMDC), Chicago (IL), USA.

Dajaku, G.; Spas, S.; Dajaku, X.; Gerling, D.: "Comparison of Two FSCW PM Machines for Integrated Traction Motor/Generator", 2015 IEEE International Electric Machines and Drives Conference (IEMDC), Coeur d'Alene (ID), USA.

Baliga, B.J., "Fundamentals of Power Semiconductor Devices," Springer US, ISBN 9780387473147, 2010.

Fairchild Semiconductor, "FDBL86361\_F085 N-Channel PowerTrench® MOSFET: Rev. C1".

Patzak, A. and Gerling, D., "Design of a multi-phase inverter for low voltage high power electric vehicles," 2014 IEEE International Electric Vehicle Conference (IEVC), Florence, Italy: 1–7.

Patzak, A., Bachheibl, F., Baumgardt, A., Dajaku, G. et al., "Driving Range Evaluation of a Multi-Phase Drive for Low Voltage High Power Electric Vehicles," 2015 International Conference on Sustainable Mobility Applications, Renewables and Technology (SMART2015), Kuwait City, Kuwait.

### Sharing: The Future of Urban Mobility

Klaus Bogenberger

Schmöller, S., Weikl, S., Müller, J., Bogenberger, K. (2015), Empirical analysis of free-floating carsharing usage: The Munich and Berlin case, *Transportation Research Part C*, Vol. 56, p. 34–51.

Reiss, S., Paul, F., Bogenberger, K. (2015): Empirical Analysis of Munich's free-floating Bike Sharing System: GPS-Booking Data and Customer Survey among Bike Sharing Users, 94th Annual Meeting of the Transportation Research Board.

## Security and Crisis Management

### Security Politics in a Globalized World

Carlo Masala and Susanne Fischer

Fischer, Susanne/Masala, Carlo 2016: Die Politik der inneren Sicherheit nach 9/11. In: Fischer, Susanne/Masala, Carlo (Eds.): *Innere Sicherheit nach 9/11. Immer neue Sicherheitsbedrohungen und (immer) neue Sicherheitsmaßnahmen?* Wiesbaden: Springer VS, 1–9.

Albrecht, Thorsten/Masala, Carlo/Tsetsos, Konstantinos 2015: *Maritime Security in the Mediterranean – Europe's fragile underbelly.* In: Krause, Joachim/Bruns, Sebastian (Eds.): *Handbook Naval Strategy and Security*, London: Routledge, 118–132.

## Imprint

### Universität der Bundeswehr München

Werner-Heisenberg-Weg 39  
85577 Neubiberg  
Germany  
Tel.: +49 89 6004-0  
info@unibw.de  
www.unibw.de  
ISSN 2510-1714

### Publisher

**Prof. Dr. Merith Niehuss,**  
President at Universität der Bundeswehr München

**Prof. Dr.-Ing. Karl-Christian Thienel,**  
Vice-President Research at Universität  
der Bundeswehr München

### Editorial Office

Michael Brauns  
Daniela Drutzel  
Daniela Lambertz  
Eva Olschewski  
Melina Saur  
Achim Vogel

### Authors

Prof. Dr.-Ing. Jörg Böttcher  
Prof. Dr.-Ing. Klaus Bogenberger  
Prof. Dr. Gabi Dreö Rodosek  
Dr. Susanne Fischer  
Prof. Dr.-Ing. habil. Norbert Gebbeken  
Prof. Dr.-Ing. Dieter Gerling  
Prof. Dr.-Ing. Thomas Kuttner  
Prof. Dr. Carlo Masala  
Prof. Dr.-Ing. Kristin Paetzold  
Prof. Dr. Helga Pelizäus-Hoffmeister  
Prof. Dr. Axel Schaffer  
Prof. Dr.-Ing. Hans-Joachim Wünsche

### Design and Coordination

Just Imagine, Germering  
Susanne Koppenhöfer, Thomas Benz

### Credits

Thomas Benz, except p. 4 fotolia; p. 5 left: BMW;  
p. 5 right: iStockphoto; p. 14 and 16: Norbert Gebbeken;  
p. 17 No. 1–3: FEMA 430; No. 4–5: Norbert Gebbeken;  
p. 18 left: Swarovski Holger Kanuf, alphamesh;  
p. 18 right: Norbert Gebbeken; p. 19 No. 1–2: Norbert Gebbeken;  
p. 20 bottom left: Andreas Praefcke; p. 30 iStockphoto;  
p. 33 No. 1–3: Dieter Gerling; p. 34 bottom: Dieter Gerling;  
p. 38–40 Klaus Bogenberger; p. 48 UniBw München, TAS;  
p. 51 No. 1 UniBw München, TAS; p. 51 No. 2 PIZ Heer;  
p. 51 No. 3 Kurt Fuchs / CoTeSys; p. 52 left and center: UniBw München;  
p. 52 right: Thorsten Lüttel; p. 54–55 Kurt Fuchs / CoTeSys;  
p. 63 Jörg Böttcher; p. 66 Susanne Koppenhöfer;  
p. 69 center left: fotolia; p. 69 center right: zoonar; p. 70 fotolia;  
p. 71 and 79 Universität der Bundeswehr München

### English Language Editing

executive english, Munich  
Beth Negus, Harry Waterstone

### Printing

Alfred Hintermaier, Offsetdruckerei + Verlag, Munich  
Circulation 2,000

© 2016 all communications should be directed to the  
Universität der Bundeswehr München, Corporate Communications,  
Werner-Heisenberg-Weg 39, 85577 Neubiberg, Germany.

All rights reserved. Brief citing from this magazine can be done with  
the express reference to the Professor/author in conjunction with the  
following source: "Research Spotlights. Universität der Bundeswehr  
München. Edition 1, 2016."  
Reprinting, publication both on and offline and large citations require  
the authorization of the Universität der Bundeswehr München directly.





**Universität der Bundeswehr München**

Werner-Heisenberg-Weg 39  
85577 Neubiberg  
Germany

Tel.: +49 89 6004-0  
[info@unibw.de](mailto:info@unibw.de)  
[www.unibw.de](http://www.unibw.de)



